



CITY OF SOMERVILLE, MASSACHUSETTS  
ELECTION DEPARTMENT

KATJANA BALLANTYNE  
MAYOR

May 7, 2024

Kimberley Wells  
City Clerk  
Somerville City Hall  
93 Highland Avenue  
Somerville, Ma 02143

2024 MAY - 7 A 10:55  
CITY CLERK'S OFFICE  
SOMERVILLE, MA

Dear Ms. Wells:

We hereby certify that the Six (6) pages of the petition ("Zoning Map Amendment – Application Form") given to us by your office contains the names of Fifteen (15) registered Somerville voters designated as such by a red check mark to the left of the name.

✓ against the name of each qualified voter certified.

N - no such registered voter at that address, or address is illegible.

S - unable to identify signature as that of voter because of form of signature, or signature is illegible.

T - already signed

BOARD OF ELECTION COMMISSIONERS

*Justin M. Brown*  
*Kelly J. Coon*  
*Michael P. Salerno*



CITY HALL • 93 HIGHLAND AVENUE • SOMERVILLE, MASSACHUSETTS 02143  
(617) 625-6600 EXT. 4200 • FAX: (617) 625-5643  
EMAIL: ELECTIONS@somervillema.gov • www.somervillema.gov

ADAM DASH & ASSOCIATES

ATTORNEYS AT LAW

48 GROVE STREET, SUITE 304  
DAVIS SQUARE  
SOMERVILLE, MA 02144

TELEPHONE (617) 625-7373  
FAX (617) 625-9452  
www.adamdashlaw.com

2024 MAY -6 P 4: 17

CITY CLERK'S OFFICE  
SOMERVILLE, MA

ADAM DASH  
PAUL METSCHER  
MARK SHEEHAN

VIA HAND DELIVERY

May 6, 2024

Clerk's Office  
1<sup>st</sup> Floor, City Hall  
93 Highland Avenue  
Somerville, MA 02143

RE: Somernova Innovation Sub-Area Overlay District

Dear Sir/Madam:

Enclosed please find the Zoning Map Amendment Application regarding the above-referenced Somernova Innovation Sub-Area Overlay District.

Please let me know when this matter will be heard.

If you have any questions, please feel free to contact me.

Thank you.

Very truly yours,



Adam Dash



# CITY OF SOMERVILLE

Office of Strategic Planning & Community Development

ELECTIONS DEPT.  
SOMERVILLE, MA

2024 MAY -6 P 4:17

## ZONING MAP AMENDMENT • APPLICATION FORM

CITY CLERK'S OFFICE  
SOMERVILLE, MA

Per Article 15.6.2 of the Somerville Zoning Ordinance (SZO), an individual property owner or ten (10) registered voters of the City of Somerville may petition the Somerville City Council to change the maps of the Somerville Zoning Atlas in response to changes in City policy or real-world conditions. To submit a map amendment petition to the City Council, the following must be provided:

1. A completed Zoning Map Amendment Application Form.
2. A copy of the appropriate Zoning Atlas map(s) with the proposed change(s) clearly noted.
3. A letter addressed to the City Council including a description of the proposed changes and the purpose for the petition.

Submit all required documents to:

City Clerk's Office  
1<sup>st</sup> Floor, City Hall  
93 Highland Avenue  
Somerville, MA 02143

Property to be changed

Property Address: 8 PARK STREET		
Map: 53	Block: A	Lot: 1
Property Address: 10 PARK STREET		
Map: 53	Block: A	Lot: 1A
Property Address: 504 SOMERVILLE AVENUE		
Map: 53	Block: A	Lot: 6
Property Address: 7-9 PROPERZI WAY		
Map: 53	Block: A	Lot: 8
Property Address: 15-17-19-21-27 PROPERZI WAY		
Map: 53	Block: A	Lot: 9
Property Address: 29 PROPERZI WAY		
Map: 53	Block: A	Lot: 9A
Property Address: 26-28-32 PARK STREET		
Map: 53	Block: A	Lot: 10
Property Address: 26-28-32 PARK STREET		
Map: 53	Block: A	Lot: 11
Property Address: 29 PROPERZI WAY		
Map: 53	Block: A	Lot: 12

Property Address: 8-14 TYLER STREET		
Map: 53	Block: A	Lot: 13
Property Address: 40 PARK STREET		
Map: 53	Block: A	Lot: 14
Property Address: 40 PARK STREET		
Map: 53	Block: A	Lot: 15
Property Address: 40 PARK STREET		
Map: 53	Block: A	Lot: 15A
Property Address: 8-14 TYLER STREET		
Map: 53	Block: A	Lot: 16
Property Address: 8-14 TYLER STREET		
Map: 53	Block: A	Lot: 16A
Property Address: 8-14 TYLER STREET		
Map: 53	Block: A	Lot: 17
Property Address: 8-14 TYLER STREET		
Map: 53	Block: A	Lot: 18A
Property Address: 8-14 TYLER STREET		
Map: 53	Block: A	Lot: 18B
Property Address: 8-14 TYLER STREET		
Map: 53	Block: A	Lot: 19
Property Address: 8-14 TYLER STREET		
Map: 53	Block: A	Lot: 20
Property Address: 8-14 TYLER STREET		
Map: 53	Block: A	Lot: 20B
Property Address: 8-14 TYLER STREET		
Map: 53	Block: A	Lot: 20C
Property Address: 8-14 TYLER STREET		
Map: 53	Block: A	Lot: 20D
Property Address: 8-14 TYLER STREET		
Map: 53	Block: A	Lot: 20E
Property Address: 8-14 TYLER STREET		
Map: 53	Block: A	Lot: 21



Property Address: 15 DANE STREET		
Map: 53	Block: B	Lot: 12
Property Address: 7-9 TYLER STREET		
Map: 53	Block: B	Lot: 15
Property Address: 460 SOMERVILLE AVENUE		
Map: 64	Block: A	Lot: 1
Property Address: 444 SOMERVILLE AVENUE		
Map: 64	Block: A	Lot: 2
Property Address: 440 SOMERVILLE AVENUE		
Map: 64	Block: A	Lot: 3
Property Address: 30 DANE STREET		
Map: 64	Block: A	Lot: 8
Property Address: 24-28 DANE STREET		
Map: 64	Block: A	Lot: 9
Property Address: 440 Somerville Avenue, Unit 1A		
Map: 64	Block: A	Lot: 3/1A
Property Address: 440 Somerville Avenue, Unit 1B		
Map: 64	Block: A	Lot: 3/1B
Property Address: 440 Somerville Avenue, Unit 1C		
Map: 64	Block: A	Lot: 3/1C
Property Address: 440 Somerville Avenue, Unit 1D		
Map: 64	Block: A	Lot: 3/1D
Property Address: 440 Somerville Avenue, Unit 2		
Map: 64	Block: A	Lot: 3/2
Property Address: 440 Somerville Avenue, Unit 3A		
Map: 64	Block: A	Lot: 3/3A
Property Address: 440 Somerville Avenue, Unit 3B		
Map: 64	Block: A	Lot: 3/3B
Property Address: 502 Somerville Avenue		
Map: 53	Block: A	Lot: 7
Property Address:		
Map:	Block:	Lot:

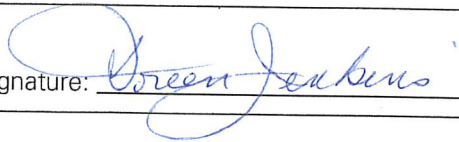

✓ Name: Doreen Jenkins  
Address: 70 Lincoln Apt # 7010  
Signature: 

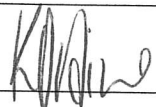
✓ Name: Kevin Dahn  
Address: 89 Grant St  
Signature: 

✓ Name: Charlene Pignone  
Address: 32 Jacques #215  
Signature: 

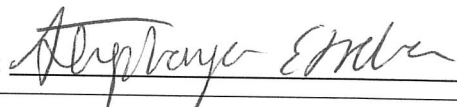
✓ Name: Stephanya Etrella  
Address: 15 River Road  
Signature: 

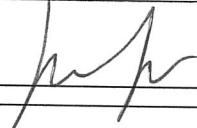
✓ Name: Laura Jean-Baptiste  
Address: 1011 Boston Ave  
Signature: 

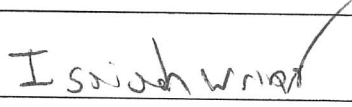
✓ Name: Issiah Wright  
Address: 50 Laurel Street  
Signature: 

Name: \_\_\_\_\_  
Address: \_\_\_\_\_  
Signature: \_\_\_\_\_

Name: \_\_\_\_\_  
Address: \_\_\_\_\_  
Signature: \_\_\_\_\_

Name: \_\_\_\_\_  
Address: \_\_\_\_\_  
Signature: \_\_\_\_\_

Name: \_\_\_\_\_  
Address: \_\_\_\_\_  
Signature: \_\_\_\_\_

For ten (10) registered voters:

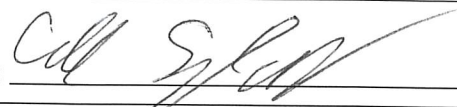
✓ Name: Cole Salamone	Signature: 
Address: 99 Hudson St. Somerville	

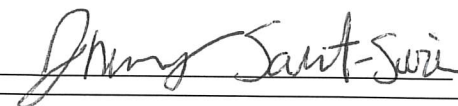
✓ Name: Jeremy Sant-Sorn	Signature: 
Address: 27 Troll St. Somerville MA	

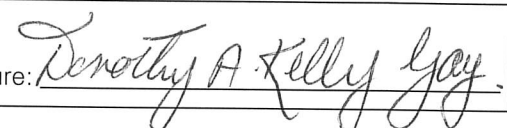
✓ Name: DOROTHY A. KELLY GAY.	Signature: 
Address:	

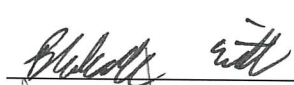
✓ Name: Blakeslee Evert	Signature: 
Address: 17 Laurel Terrace	

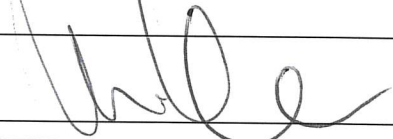
✓ Name: LUIS FERNANDEZ	Signature: 
Address: 106 college Ave #2	

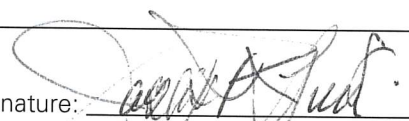
✓ Name: Joseph P. Lynch DE	Signature: 
Address: 10 Henderson St	

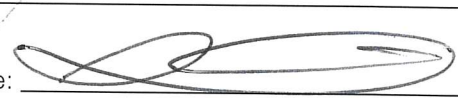
✓ Name: Iana Krechin	Signature: 
Address: 7 waldo Ave #1	

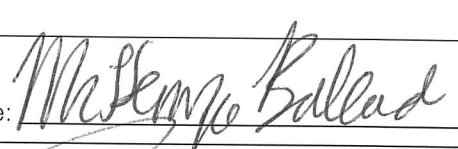
✓ Name: Kenzie Ballard	Signature: 
Address: 67 Marion St Apt 2 Somerville, MA 02143	

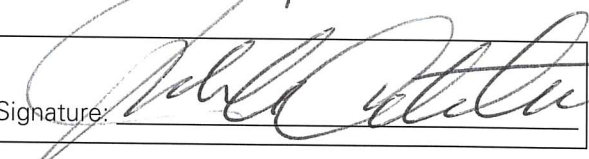
✓ Name: Joseph A Curtatone	Signature: 
Address: 130 Ten Hills Road Somerville, MA 02145	

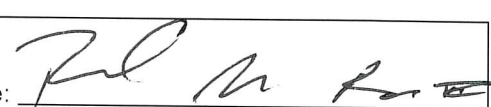
✓ Name: PAUL RHODES	Signature: 
Address: 13 FOSKETT ST APT 2	

## ZONING MAP AMENDMENT APPLICATION

### Properties:

8 Park Street, 53/A/1  
10 Park Street, 53/A/1A  
504 Somerville Avenue, 53/A/6  
7-9 Properzi Way, 53/A/8  
15-27 Properzi Way, 53/A/9  
29 Properzi Way, 53/A/9A and 12  
26-32 Park Street, 53/A/10 and 11  
8-14 Tyler Street, 53/A/13, 16, 16A, 17, 18A, 18B, 19, 20, 20B, 20C, 20D, 20E, and 21  
40 Park Street, 53/A/14, 15 and 15A  
15 Dane Street, 53/B/12  
7-9 Tyler Street, 53/B/15  
30 Dane Street, 64/A/8  
24-28 Dane Street, 64/A/9  
460 Somerville Avenue, 64/A/1  
444 Somerville Avenue, 64/A/2  
440 Somerville Avenue, 64/A/3  
440 Somerville Avenue, Unit 1A, 64/A/3/1A  
440 Somerville Avenue, Unit 1B, 64/A/3/1B  
440 Somerville Avenue, Unit 1C, 64/A/3/1C  
440 Somerville Avenue, Unit 1D, 64/A/3/1D  
440 Somerville Avenue, Unit 2, 64/A/3/2  
440 Somerville Avenue, Unit 3A, 64/A/3/3A  
440 Somerville Avenue, Unit 3B, 64/A/3/3B  
502 Somerville Avenue, 53/A/7

**Owners:** Rafi Investments-Somerville, LLC (see below list)  
Extra Space of Somerville LLC (460 Somerville Avenue)  
Krisco Realty LLC (444 Somerville Avenue)  
Labrava Realty, LLC (440 Somerville Avenue, Units 1A, 1C, and 1D)  
Thomas E. Kruskal and Deborah W. Kruskal, Trustees of The Kruskal  
Somerville Realty Trust (440 Somerville Avenue, Unit 1B)  
Paul E. Cusack and Susan R. Cusack, Trustees of the Paul E. Cusack Trust  
and Paul E. Cusack and Susan R. Cusack, Trustees of the Susan R.  
Cusak Trust (440 Somerville Avenue, Unit 2)  
BOLSE, LLC (440 Somerville Avenue, Unit 3A)  
Abigail Richards Crossen, Trustee of Susimo Realty Trust (440 Somerville  
Avenue, Unit 3B)  
MAPESA OG TWO LLC (502 Somerville Avenue)

**Applicants: Rafi Investments-Somerville, LLC**  
**Cole Salamone**  
**Jhenny Saint-Surin**  
**Dorothy A. Kelly Gay**  
**Blakeslee Evitt**  
**Luis Fernandez**  
**Joseph P. Lynch, Jr.**  
**Ilana Krepchin**  
**Kenzie Ballard**  
**Joseph A. Curtatone**  
**Paul Rhodes**  
**Doreen Jenkins**  
**Kevin Dodin**  
**Charlene Pignore**  
**Stephanya Estrella**  
**Laura Jean-Baptiste**  
**Isaiah Wright**

**Agent for Applicant Rafi Investments-Somerville, LLC: Adam Dash, Esq.**

**To: Hon. Matthew McLaughlin, Ward 1 Councilor and Chair of the Land Use  
Committee**  
**Hon. J.T. Scott, Ward 2 Councilor**  
**Kimberly Wells, City Clerk**  
**Sarah Lewis, Planning Director**

**May 6, 2024**

The above-referenced Applicant, Rafi Investments-Somerville, LLC (“Rafi”) owns the properties located at the following Assessors Map, Lot and Block numbers and addresses:

8 Park Street, 53/A/1 - Zoned as MR4  
10 Park Street, 53/A/1A - Zoned as MR4  
504 Somerville Avenue, 53/A/6– Zoned as MR4  
7-9 Properzi Way, 53/A/8 -Zoned as MR4  
15-27 Properzi Way, 53/A/9 – Zoned as FAB  
29 Properzi Way, 53/A/9A and 12 – Zoned as FAB  
26-32 Park Street, 53/A/10 and 11 – Zoned as FAB  
8-14 Tyler Street, 53/A/13, 16, 16A, 17, 18A, 18B, 19, 20, 20B, 20C, 20D, 20E, and 21 –  
Zoned as FAB  
40 Park Street, 53/A/14, 15 and 15A– Zoned as FAB  
15 Dane Street, 53/B/12 - Zoned as FAB  
7-9 Tyler Street, 53/B/15 – Zoned as FAB  
30 Dane Street, 64/A/8 - Zoned as FAB

24-28 Dane Street, 64/A/9 - Zoned as FAB

These properties are a series of buildings, most of which are known as the Somernova campus. These properties are currently located in either the Fabrication (“FAB”) or Mid-Rise 4 (“MR4”) zoning district as indicated, and are not located in a Transit Area.

The Applicants also seek to include the following properties which are not owned by any of the Applicants and which are located at the following Assessors Map, Lot and Block numbers and addresses:

460 Somerville Avenue, 64/A/1 – Zoned as FAB

444 Somerville Avenue, 64/A/2 – Zoned as FAB

440 Somerville Avenue, 64/A/3, 3/1A, 3/1B, 3/1C, 3/1D, 3/2, 3/3A and 3/3B – Zoned as FAB (this property is 7 condominium units as identified above)

502 Somerville Avenue, 53/A/7-Zoned as MR4

The Applicants, being Rafi and more than ten (10) registered voters in the City of Somerville as identified above, hereby seek to amend the Somerville zoning map for said properties owned by Rafi, and also for the additional properties listed above which are not owned by Rafi or any of the other Applicants, by placing a new overlay district onto said properties to be called the “Somernova Innovation Sub-Area”, otherwise to be known as the “SI Overlay District”, and including the language filed hereto which would be inserted into Article 8 of the Somerville Zoning Ordinance as the new Section 8.4.19.

Applicants only seek to create this new SI Overlay District for said properties, and they do not propose to change the underlying base zoning districts for said properties. Likewise, no existing Pedestrian Street District designations are proposed to be changed.

The properties being placed in this new SI Overlay District are mostly currently located in the FAB zoning district, but some are located in the Mid-Rise 4 (“MR4”) zoning district, as can be seen on the existing and proposed Somerville zoning maps filed herewith.

The purpose of placing said properties into this new SI Overlay District is to redevelop them in order to create meaningful places rooted in authentic community values, with a shared purpose for sustainable and direct future use based upon Rafi’s work over the past five years collaborating with the community to develop a comprehensive approach that promotes equity for our youth, our planet, and for Somerville, as well as to foster the Arts. Community benefits would encompass more than physical structures. They would include partnerships, mentor programs, access to education and resources, and pathways to future employment.

Without the zoning map change being requested, the redevelopment of these properties could not happen due to the constraints of their current underlying zoning districts.



Attached please find an Executive Summary which calls out changes made to the zoning based on community feedback.

At the current rate of human consumption and growth, achieving net zero energy use alone falls short of what is necessary. It is imperative to assist scientists in addressing the climate crisis by fostering an environment which encourages companies to develop technologies that heal and regenerate our planet. With the Somernova campus, Rafi is dedicated to constructing resilient spaces tailored to accommodate Tough Tech and Climate Tech enterprises. Unfortunately, several companies affiliated with the Greentown Labs or MIT's Engine community have begun to outgrow the Somernova campus, exploring opportunities elsewhere. Somerville cannot allow this trend to persist. These companies play a vital role in climate action initiatives while supporting local businesses, generating employment, and offering mentorship opportunities to the City's residents and youth. It is these compelling factors which drive this initiative to expand the Somernova ecosystem.

Over the next 10 years, Rafi will embark on an ambitious expansion plan for the Somernova campus, encompassing an additional 1.6 million square feet of industrial research and development ("R&D"), Arts and Creative Enterprises ("ACE"), housing, as well as creative other space. If this zoning map change is granted, Rafi would work to expand the Somernova campus to integrate a diverse range of uses, financial models, and strategic alignments carefully crafted to cater to the community's specific requirements, while simultaneously fostering the growth of startups and the broader innovation economy in the region, as well as the local Arts community.

As can be seen by having more than the required ten (10) registered voters in the City of Somerville join with Rafi in this Application, there is widespread support for such goals.

SomerVision 2040's goals regarding the need for measures to address climate change and sustainability concerns can be met by this proposed zoning map change.

To quote various portions of SomerVision 2040:

*We need to integrate sustainability in all City processes, especially the way we live and move about.*

*Our infrastructure plays a critical role in improving our sustainability and resiliency to future climate events. We should explore traditional and innovative ways of addressing our problems.*

In harnessing the momentum of climate innovation, Rafi's vision for the Somernova campus extends beyond the expansion of physical infrastructure. The proposed SI Overlay District requires the establishment of a community center that is proposed to be owned and programmed by members of the Somerville community. As part of Rafi's commitment, it will provide ongoing support to ensure the success of this Community Center. The aspiration is for this

facility to serve as a pioneering model, inspiring the creation of similar community centers throughout the City.

The community center will offer career pathways and workforce development opportunities for youth near the heart of Union Square – a critical hub for tough tech and climate-tech innovation. The community center will provide the City’s most vulnerable young people access to innovators and the entrepreneurial ecosystem at Somernova. Rafi’s intent is for there to be pathways for youth in these spaces and talent pipelines among leading companies at Somernova to ensure climate-tech jobs and training are integral to the community that this new SI Overlay District is creating. Rafi has already seen strong connections between the existing youth-driven community center pilot program throughout the Somernova innovation hub, via its green job training programs, internships, financial literacy programs, and STEAM programming happening on the Somernova campus today.

In addition to youth-oriented programs, this versatile community center space will be open to various community groups, offering a platform for hosting a wide array of engaging activities. Imagine community dinners that bring neighbors together, vibrant cultural festivals that celebrate diversity, thrilling eSports competitions that foster camaraderie, captivating open mic nights showcasing local talent, and invaluable mental health workshops that promote overall well-being. Rafi warmly invites you to actively participate in shaping the programming of this community center, ensuring it truly reflects the aspirations and needs of the community. Together, we can make it a vibrant hub that enriches the lives of residents of all ages.

The entire Somernova team expresses its gratitude to all who have actively engaged with it, contributing to the co-creation of this shared vision for the future of the Somernova campus via the City’s first zoning area focused on climate and equity innovation.

Therefore, the Applicants respectfully request that the zoning map be amended to create a new Somernova Innovation Sub-Area, in accordance with the language filed herewith regarding the properties shown on the proposed zoning map filed herewith.



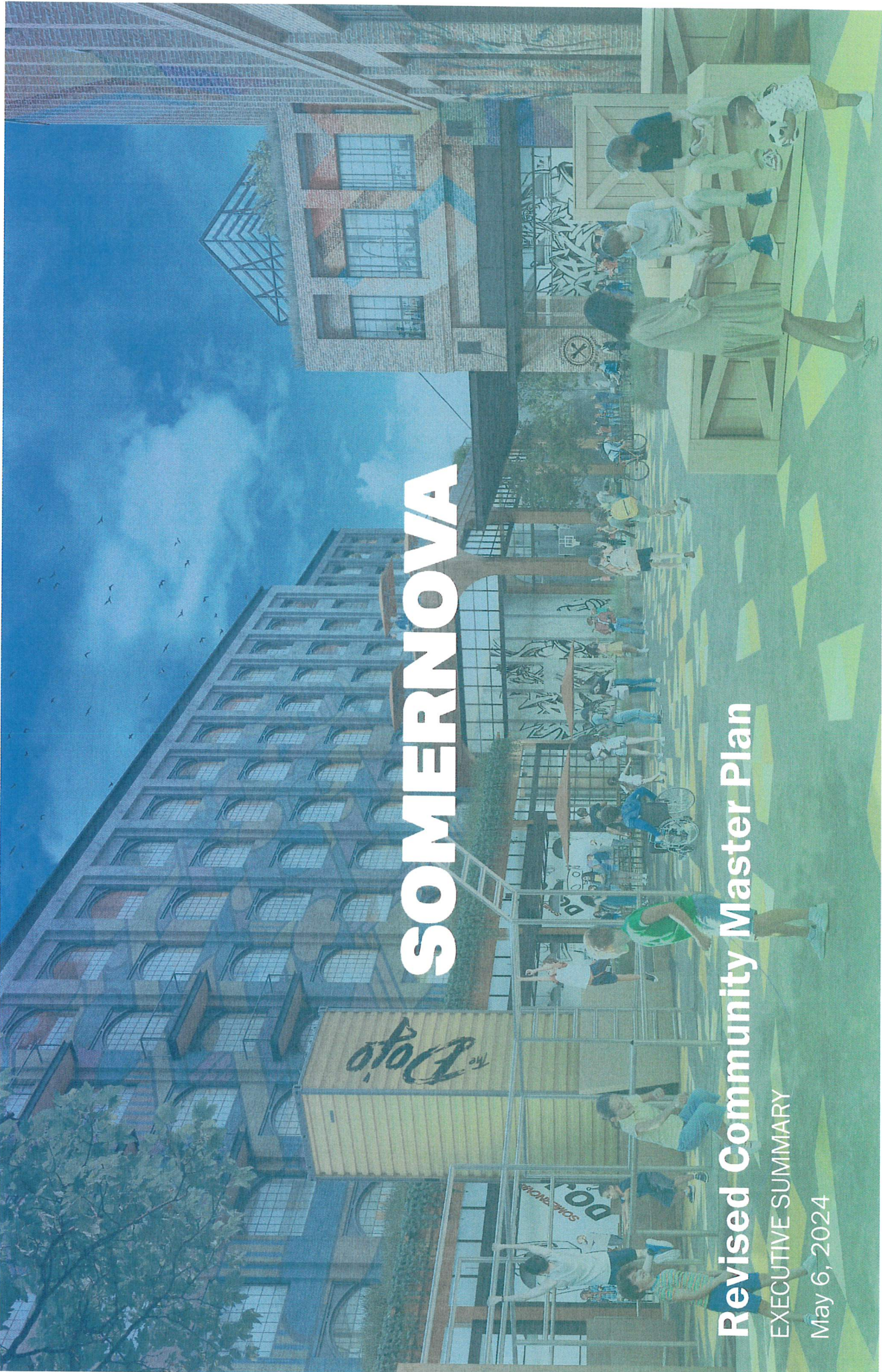

# SOMERNOVA

## Revised Community Master Plan

EXECUTIVE SUMMARY

May 6, 2024



# CAMPUS EXPANSION EXECUTIVE SUMMARY

## Somernova Innovation Sub-Area Revised May 6, 2024

Deeply rooted in the neighborhood vibe of Somerville's Union Square, Somernova (aka Somerville's Innovation Hub) is a 7.4 acre campus for innovation and community. Our mission is to help entrepreneurs and companies iterate and grow faster. Somernova is home to an eclectic tenant mix, including Greentown Labs, The Boulderling Project, Form Energy, The Engine by MIT, Aeronaut Brewing, Sublime Systems, Eden Geopower, Tank Design, Tender Foods, De-Ice, Fleet Robotics, Somerville Bike Kitchen, Somerville Media Center, Riverside Community Care, Carollicious, Somerville Chocolate, The Studio for Sculptural Arts, and The Dojo @ Somernova.

While their work spans vast industry sectors, our tenants share in their collective commitment to making the world a better place for everyone. Somernova is an entrepreneurial ecosystem welcome to all and built for tough tech. Tough Tech is transformational technology solving the world's most important challenges, such as combating climate change and improving public health, through the convergence of breakthrough science, engineering and leadership.

Since the early part of the 21st century, SOMERNOVA (formerly known as the Ames Business Park) has been known as a place where people co-create, iterate, and test the boundaries of what is possible. From American Tube Works and Ames Safety Envelope to SOMERNOVA - the spirit of innovation and manufacturing continues. The campus has evolved into one of the region's hottest clusters for rapidly growing early-stage and venture backed climate and tough tech companies. These companies want to be here because the talent is here.

The climate & tough tech companies located in Somernova's current 7.4 acres are some of the most rapidly growing in the world. Form Energy, for example, is developing a new class of cost-effective, multi-day energy storage systems that will enable a reliable and fully-renewable electric grid year-round. SOMERNOVA is able to ensure their rapidly growing businesses are able to solve some of the world's most pressing climate challenges and remain in Somerville while doing so.

At the current rate of human consumption and growth, achieving net zero alone falls short of what is necessary. Our imperative is to assist scientists in addressing the climate crisis by fostering an environment that encourages companies to develop technologies that help and regenerate our planet. In harnessing the momentum of climate innovation, our vision extends beyond the expansion of physical infrastructure linking the growing climate tech ecosystem with direct benefits to the Somerville community, designed by the Somerville community.

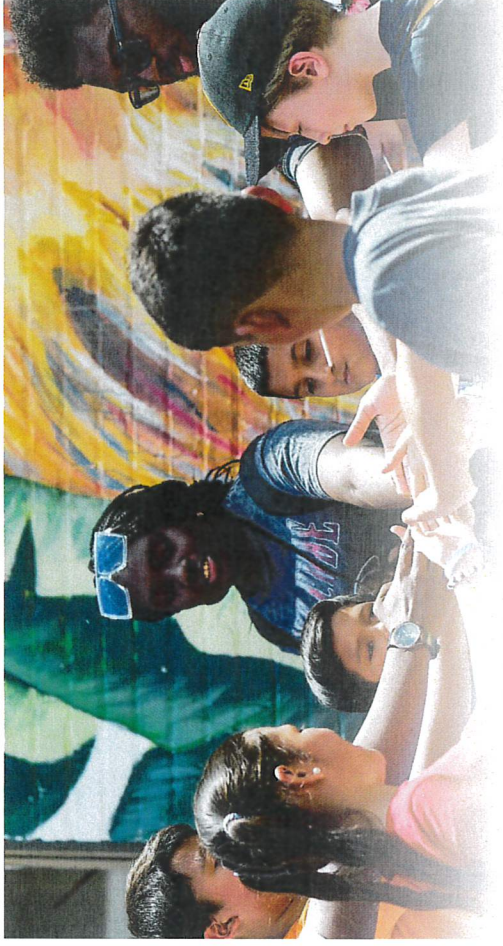

**Young people are the greatest agents of  
change in a society. They are the torchbearers  
of the world.**



# SPACE FOR CLIMATE & TOUGH TECH COMPANIES

In December of 2023, Somernova proposed a 1.9 million SF campus expansion project, which was withdrawn in February 2024 after receiving feedback from the Somerville community and Union Square Neighborhood Council. We've engaged in extensive conversations and, as a result, made significant changes to the previously withdrawn Climate & Equity Innovation Sub-Area Zoning Draft.

Since the withdrawal of the original version, our team has redesigned the proposed zoning amendment to retain much of the same impact, but better reflect what we heard from the community about how Somernova can best serve Somerville. Our revised proposal envisions a 1.6 million SF campus expansion project comprising R&D and commercial space for growing climate & tough tech companies, local & independent retail, a vibrant music and arts ecosystem, housing, daycare, greenspace & youth-driven community-center. Central to the future of the campus, the new 12,000 SF, turn key, youth-driven community center will empower Somerville's future leaders with the resources needed to co-create the City's first youth center and connect them to Somernova's vibrant tough tech ecosystem.

The proposed Somernova Innovation Sub-Area zoning will allow companies currently incubating in Greentown Labs and in Somernova's innovation hub to grow into their next level space and eventually company headquarters, R&D, light manufacturing, etc. The revised zoning is designed to help preserve and scale the City's music and arts ecosystem by creating affordable arts spaces such as music recording and rehearsal space, varying sized live music venues featuring local and independent operators

The climate, arts and equity initiative will also link the growing climate tech ecosystem with direct benefits to the community by delivering a state-of-the-art community center, support equitable pathways to jobs, local artists, small businesses, and other opportunities to be defined in line with the changing needs of the community.

Below is a brief synopsis of the changes made and reflected in the revised zoning draft:

## SCALE

Community Feedback: The buildings are too tall.

Action Taken: The buildings have been scaled back to 6 to 9 stories (85 to 185 feet) from 9 to 14 stories (45 to 245 feet) with a range of step-backs and heights to best fit the neighborhood context. The project has been reduced to 1.6m SF from 1.9m SF.

## MOBILITY

Community Feedback: The project has too much parking and is too car-centric.

Action Taken: Parking has been reduced by 40% to 748 spaces from 1250, representing a .43/1000 SF parking ratio—the lowest commercial parking ratio to date in Somerville. Bike parking has been increased to 500 spots from 400 spots, a 25% increase.

Somernova is committed to future proofing the campus by ensuring block 3 is transit ready to connect directly to a potential MBTA train stop. The campus will include a multi-modal, mobility hub that prioritizes the pedestrian with services such as a North-South Connector shuttle, open to the public, designed with the goal of connecting Somernova to the Red, Green, and Orange Lines.

## HOUSING

Community Feedback: Campus expansion should include housing.

Action Taken: The project now includes a six-story, 100-unit residential building with a minimum of 20% of units designated as affordable.

## CIVIC SPACE

Community Feedback: Campus expansion does not have

02

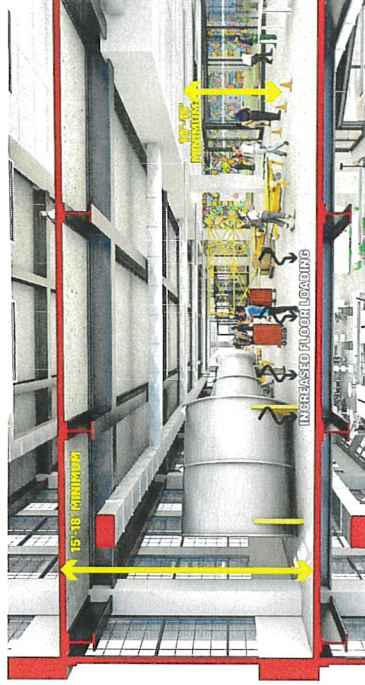

enough civic space.

Action Taken: We increased our civic space to 18% from 12%, including extensive civic outdoor space with a 37,000 SF Courtyard/Park, 7,200 SF "Daycare" Park, and 11,000 SF Park. This includes a new Public Room civic space type that would allow Somernova to create publicly accessible, indoor spaces that can further enhance the neighborhood's network of civic spaces.

## ARTS & CREATIVE ECOSYSTEM

Community Feedback: Campus expansion lacks commitment to the local arts community.

Action Taken: Somernova has engaged in many conversations with the Somerville arts community, and with the help of the Arts Stays Here coalition, we have collaborated on a plan for how Somernova's campus expansion could play a role in helping preserve and scale the City's music and arts ecosystem. Based on these conversations, we recognize that building ACE space alone is not enough, we must collaboratively work on an environment that is purpose-built, intentional, and funded in a larger creative ecosystem.

The Alley - An ecosystem and destination where art meets tech. It will be a place for local musicians to create, rehearse, write, record, perform, and learn. The Alley will include diversely-sized live music and performance venues, speakeasies, cafes, music/arts-focused retail, affordable music recording and rehearsal space, and more.

**Somernova's Campus expansion will include**

65,000 SF of ACE SPACE - 25,000 SF dedicated to affordable arts spaces such as music recording and rehearsal space, varying sized live music venues featuring local and independent operators. A 7,800 SF Affordable Artist Space building at 24 Dane and a significant arts and cultural component of The Dojo (community center). A Curatorial Team of local artists and arts stakeholders to help guide curation, types of businesses, operators, etc., to ensure the plan is implemented authentically.

Large-Scale Building-Sized Art (Exterior, including Murals)-Somernova Innovation Sub Area will require public art per building designed to foster opportunities for local, regional, and internationally renowned artists.



01 An existing Climate & Tough Tech located at Somernova

02 Illustration of a multi-story Climate & Tough Tech building as proposed in the campus expansion.



# EXISTING CONDITIONS

SOMERNOVA is between several of the region's key innovation drivers: Harvard, MIT, Tufts, and their surrounding commercial centers. More importantly, SOMERNOVA is at the intersection of several of Somerville's most walkable neighborhoods. Historically the factories, warehouses, and businesses located at SOMERNOVA were critical to the life and commerce of the residents surrounding this historically significant corridor. Today, this importance is even greater with the potential to address the climate crisis and the city's social welfare.

## CAMPUS LOCATION

The Site is located within the Commercial Fabrication District of Ward Two in Somerville, surrounded by Spring Hill to the north and Duck Village to the south. Park Street bounds the area to the west, Market Basket (400 Somerville Avenue) to the east, the Massachusetts Bay Transportation Authority (MBTA) Fitchburg Commuter Rail tracks to the south, and a mix of residential, commercial, and institutional properties to the north.

The SOMERNOVA Campus (the Site) comprises the following Tax Lots:

- Tax Block 59-A-20. Lots: 11A,6,8,9,9A,10,11,12,13,14,15,15A,16,16A,17,18A,18B,19,20,20B,20C,20D, and 20E

- Tax Block 64-A-9

- Tax Block 64-A-B

And the following Street addresses:

- 8 – 12 & 14 Tyler Street

- 15-21, 29 Properi Way

- 12-14, 24 & 28 Park Street

- 24, 28 & 30 Dane

- 30 & 40 Park Street



Somerville Avenue, a central commercial thoroughfare, is part of the MBTA bus network - bus route #87 with approximately 24-minute headways today, and is also part of the existing bicycle network with two dedicated bike lanes.

Service through bus route #83 is adjacent to the Site along Park Street with an average 24-minute headway. Porter Square and Union Square are each approximately ¼-mile from SOMERNOVA and 10-minute bus rides via the 83 or 87 bus routes. The MBTA Green Line serves Union Square Station. The MBTA Red Line and Commuter Rail serve Porter Square Station.

Aerial photo of SOMERNOVA from the corner of Park Street and Somerville Avenue with Boston visible in the background. The Somerville Avenue corridor can be seen on the left side.



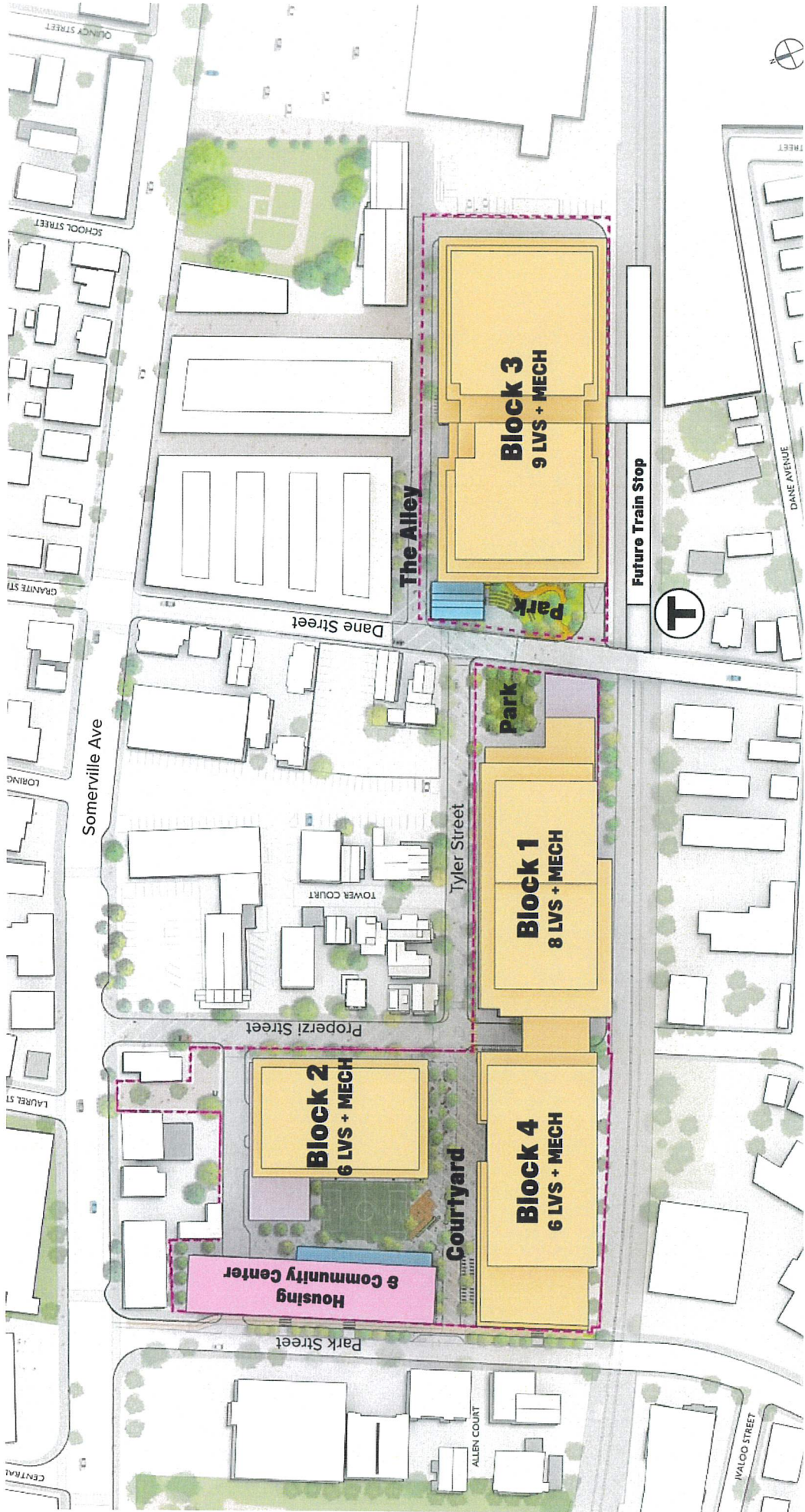

Site Plan: SOMERNOVA Campus Expansion



# PLANNED PROGRAM

Campus Expansion Summary

## Program Previous Updated

Research & Development	1.1m SF	690,000 SF
Office / Commercial	333,000 SF	300,000 SF
Arts & Creative Enterprise (ACE)	77,000 SF	65,670 SF
Community Center	25,000 SF	12,000 SF
Retail	40,000 SF Fitness	30,000 SF Fitness
	8,400 SF Daycare	5,000 SF Daycare
	6,800 SF Health & Wellness	4,200 SF Health & Wellness
	29,000 SF Food & Beverage	28,500 SF Food & Beverage
Open Space	80,000 SF	63,000 SF
Trees	100+	100+
Vehicle Parking	1250	750
Bike Parking	400	500

# ANTICIPATED BENEFITS

## Somernova Benefits

	Existing Zoning	Proposed Campus Expansion
Youth-driven Multigenerational Community Center Construction	\$0	\$5,852,105
Community Center Operating Cost / 10yrs	\$0	\$1,628,899
24 Dane Street Arts Building	\$0	\$2,423,629
<b>Total</b>	<b>\$0</b>	<b>\$9,904,634</b>

## Total Benefits

	Existing Zoning	Proposed Campus Expansion
Total Benefits (Require, Voluntary, Unique to Somernova)	<b>\$41,762,130</b>	<b>\$107,247,519</b>
Benefits per sf of development	<b>\$ 34.80/ft<sup>2</sup></b>	<b>\$ 65.45/ft<sup>2</sup></b>

# ESTIMATED TAXES, FEES, CONTRIBUTIONS, & MITIGATIONS

<b>Taxes</b>	<b>Existing Zoning</b>	<b>Proposed Campus Expansion</b>
Existing Property Tax	\$773,675	-
Projected Generated Property Tax	\$13,400,000	\$19,511,608
New Additional Taxes projected from TPI	\$9,500,000	\$16,491,357
<b>Total</b>	<b>\$22,900,000</b>	<b>\$36,002,965</b>

<b>Required Linkage</b>	<b>Existing Zoning</b>	<b>Proposed Campus Expansion</b>
Somerville Housing Trust	\$26,804,700	\$32,600,815
Somerville Jobs Trust	\$3,543,150	\$4,366,880
<b>Total</b>	<b>\$30,347,850</b>	<b>\$36,967,696</b>

# City Contributions

	Existing Zoning	Proposed Campus Expansion
<b>Community Benefits Contribution (Voluntary)</b>	\$0	\$2,932,795
<b>Off Site Infrastructure (Voluntary)</b>	\$0	\$3,654,478
<b>Large Project Contribution (Voluntary)</b>	\$0	\$3,654,478
<b>Total</b>	<b>\$0</b>	<b>\$10,241,752</b>

# City Fees

	Proposed Campus Expansion
<b>Zoning Review Fees</b>	\$945,257
<b>Planning Review Fees</b>	\$3,781,029
<b>Building Permit Fees</b>	\$23,158,805
<b>Inflow &amp; Infiltration Fees (I&amp;I)</b>	\$1,497,598
<b>Total</b>	<b>\$29,382,690</b>

# Mitigations

	Existing Zoning	Proposed Campus Expansion
<b>Utility &amp; Stormwater Improvements</b>	\$0	\$6,700,000
<b>Public Street Improvements</b>	\$0	\$6,000,000
<b>Mobility TDM's</b>	\$5,100,000	\$8,050,748
<b>Total</b>	<b>\$5,100,000</b>	<b>\$20,750,748</b>



# BLOCK 1 - DAYCARE PARK



Today anyone walking down Tyler Street experiences a long windowless wall with a loading dock open to the street. Along Dane Street, the bridge spanning the Commuter Rail tracks creates a severe grade change visible on the west side and a large parking deck on the east side. Our vision is to transform this corner into two new parks. This plan places a new park adjacent to a new daycare



center in Phase 1s research and development building. A rebuilt Tyler Street will include new street trees and a streetscape design that encourages shared space, slow vehicle speeds, and pedestrian-oriented details. Additionally, the building will have a publicly accessible garden on its roof to encourage multigenerational engagement with native plant species and gardening. Across

from the street, we envision a new park featuring a flexible design that the community can use for programming, events, and other neighborhood activities.



# BLOCK 1- TYLER STREET



Today, Tyler Street is a yield street, with parking on both sides and two-way traffic trying to make their way through. Tyler Street has very narrow sidewalks and is a challenging path for bikers. Windowless buildings on the south side are currently fronting Tyler Street. Pedestrians are constantly interrupted by driveways, loading spaces, and parking lot curb cuts.



The vision for Tyler Street is to replace the windowless buildings within SOMERNOVA with an active ground floor in the proposed R&D building in Block 1. Tyler Street will be redesigned in line with Somerville's Neighborway approach, creating a more enjoyable and safe environment for pedestrians and cyclists. The streetscape design will feature rain gardens with native plants along the street

and significantly more street trees. Street parking will be maintained on the north side of Tyler Street, interspersed between rain gardens. A decorative paving pattern extending across the street will further emphasize the Neighborway concept, creating an inviting and comfortable space for all users.



# BLOCK 2 - THE COURTYARD



In Block 2 of the campus, Somernova envisions creating Housing, a Community Center, & Space for Climate Tech Companies. The Community Center will open directly onto the new Courtyard, providing direct access to outdoor space for future programs at the Center. Above the Community Center, this image shows five residential floors, which can create approximately 100 new homes on campus.



## BLOCK 2 - THE COURTYARD & SPECIAL EVENTS



SOMERNOVA envisions a multi-purpose civic space that provides flexibility and accommodates a diverse array of uses. This image illustrates the idea of a five-on-five soccer series. We have heard from the campus tenants that they want more opportunities to come together around games. We have also heard from the community that additional space for playing and practicing would be incredibly welcome.





# BLOCK 3 - THE ALLEY



SomerNova has engaged in many conversations with the Somerville arts community and, with the help of the Arts Stays Here coalition, we have collaborated on a plan for how SomerNova's campus expansion could play a role in helping preserve and scale the City's music and arts ecosystem. Based on these conversations, we recognize that building ACE space alone is not enough, we must collaboratively

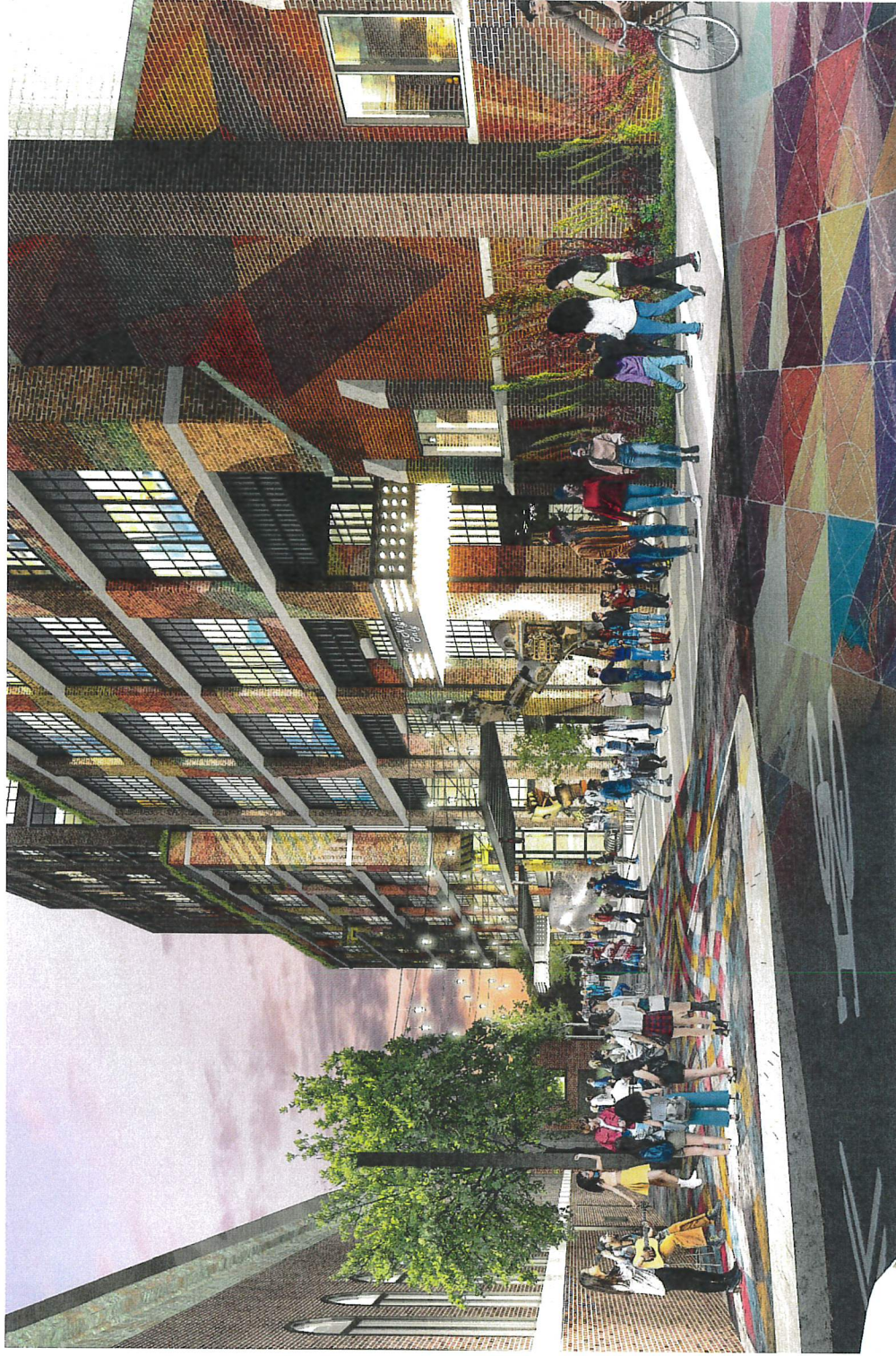

work on an environment that is purpose-built, intentional, and funded in a larger creative ecosystem. Block 3 along the Alley is envisioned to become an ecosystem and destination where music meets tech. It will be a place for local musicians to create, rehearse, write, record, perform, and learn. The Alley will include diversely-sized live music and performance venues, speakeasies, cafes, music/arts-

focused retail, affordable music recording and rehearsal space, and more.



# BLOCK 3 - THE ALLEY



The current Somernova buildings in the Alley are characterized by several large-vehicle loading docks along their facades. This section of the thoroughfare is heavily utilitarian. The proposed design for the Alley will have the ground floors of the new buildings host active and engaging uses aimed at creating a vibrant music and arts scene. The proposed buildings will respect and take inspiration



from the existing industrial architecture of this historical fabrication area. The existing utility poles and overhead electrical wiring will be moved underground, leaving a more ample and flexible space.



# BLOCK 3 - ATRIUM/ PUBLIC ROOM & POTENTIAL MBTA STATION

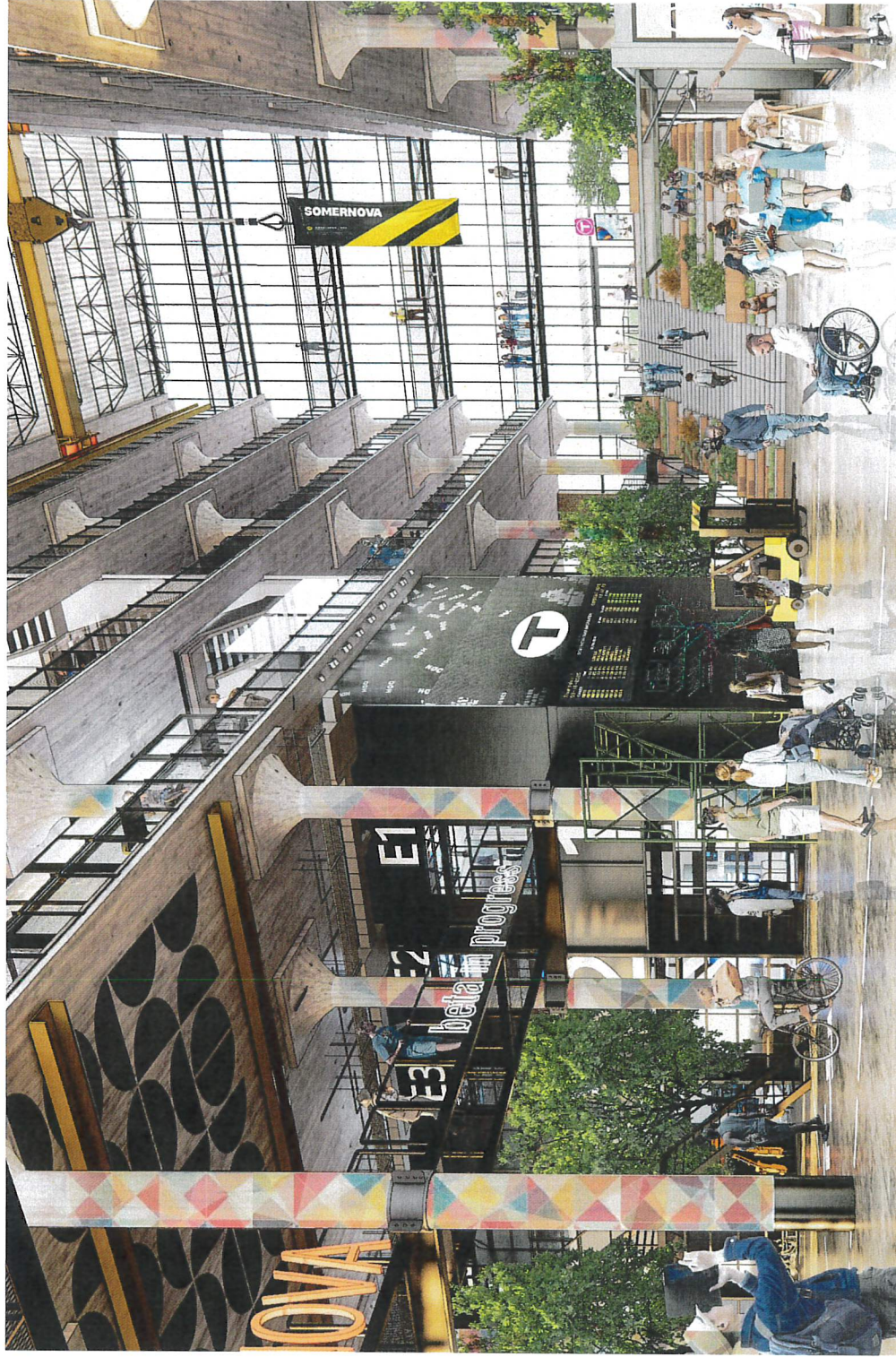

this new Public Room. This new Public Room will add to the music and arts ecosystem by providing flexible indoor space that could host local events, exhibitions, and performances.



In Block 3 of the campus, SOMERNOVA is proposing a new Public Room civic space type that will create publicly accessible indoor spaces to further enhance the neighborhood's network of civic spaces, especially during colder months. We are also committed to future-proofing this phase of the campus to be transit-ready through a direct connection to a potential MBTA train stop through



# BLOCK 3 - THE ROOF



SOMERNOVA envisions creating several upper-level and roof terraces further to enhance the network of open spaces on campus. This image shows a concept for a roof terrace in Phase 3 that will incorporate native landscaping, provide playing and leisure space, and provide flexible workspace so that the community can enjoy the outdoors.



# BLOCK 4 - PARK STREET

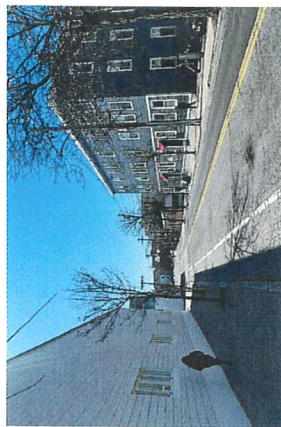

Park Street is one of the few at-grade connections over the Commuter Rail tracks into Somerville. The current street design has two travel lanes and narrow bike lanes on each side with no buffers. On the SOMERNOVA side, the sidewalk has decent dimensions and some small street trees. Today, Park Street is a service street for the Campus with two active loading dock areas. Overall, the street has a more



utilitarian function, and it is not an enjoyable experience for pedestrians or bikers. Somerville's Bicycle Network Plan designates Park Street as an essential bicyclist thoroughfare. In the future, Park Street will serve as a crucial link and point of arrival and departure for the Campus. Our proposal includes creating a two-way cycle track buffered with a lush rain garden

with native pollinators and space for new street trees. Given that the street has a limited right-of-way for all the different accessibility functions it has, the vision includes a generous sidewalk under an arcade on the SOMERNOVA side of the street. Active and attractive ground floor uses will front this arcade, prioritizing the pedestrian experience and the campus' walkability.

**THANK YOU!**

*To get involved and stay up to date with project information, please visit [somernova.community](http://somernova.community)*





# SOMERNOVA



CITY OF  
SOMERVILLE, MA  
OFFICIAL ZONING MAP

SHEET 14

1	2	3	4	5	6	7	8
2	3	4	5	6	7	8	9
3	4	5	6	7	8	9	10
4	5	6	7	8	9	10	11
5	6	7	8	9	10	11	12
6	7	8	9	10	11	12	13
7	8	9	10	11	12	13	14
8	9	10	11	12	13	14	15
9	10	11	12	13	14	15	16
10	11	12	13	14	15	16	17
11	12	13	14	15	16	17	18
12	13	14	15	16	17	18	19

EXISTING MAP

- Pedestrian Streets
- SB Overlay
- NR
- UR
- MR3
- MR4
- MR5
- CIV
- FAB
- CB

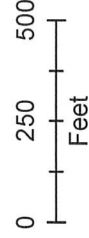
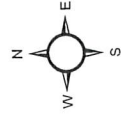

Date: March 20, 2022

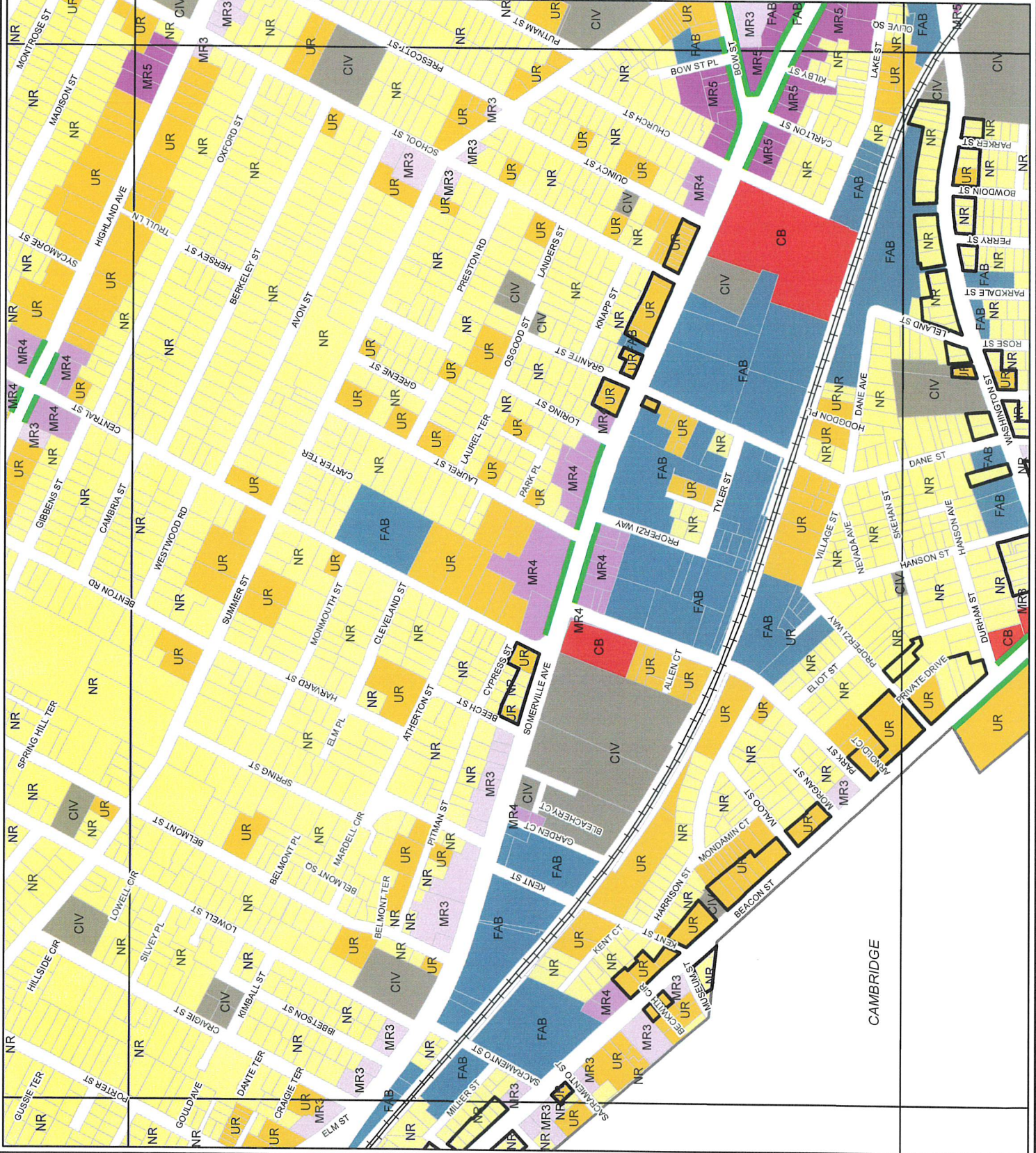



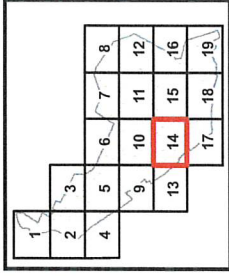

PROPOSED MAP

Pedestrian Streets  
 SB Overlay  
 MPD Overlay  
 NR  
 UR  
 MR3  
 MR4  
 MR5  
 CIV  
 FAB  
 CB

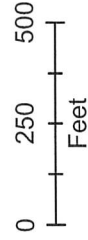

Date: March 20, 2022

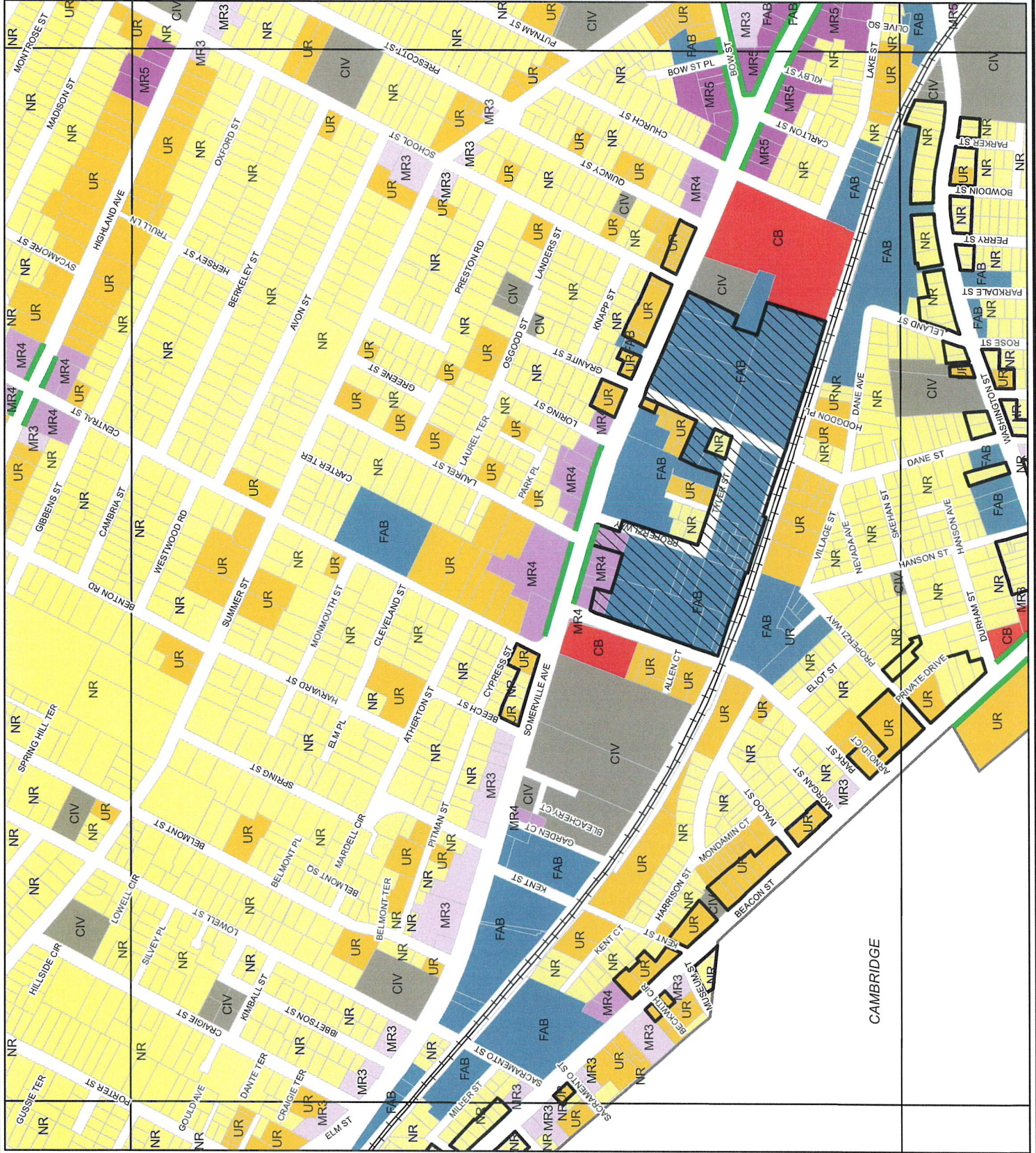

CAMBRIDGE



# 8. OVERLAY DISTRICTS

## Master Planned Development (MPD)

### 8.4 MASTER PLANNED DEVELOPMENT (MPD)

#### 1. Intent

- a. To implement recommendations of SomerVision for transformational REDEVELOPMENT.
- b. To implement design-based neighborhood and station area plans called for by SomerVision.

#### 2. Purpose

- a. To require a Master Plan Special Permit for all DEVELOPMENT requiring SUBDIVISION.
- b. To require a Master Plan Special Permit for the coordinated DEVELOPMENT of two or more LOTS.
- c. To permit real property that is not subject to an approved Master Plan Special Permit to develop by Special Permit.
- d. To permit DEVELOPMENT in accordance with zoning districts or dimensional standards that would not otherwise be available to real property outside of the MPD overlay.
- e. To require that thoroughfares and CIVIC SPACES developed in each sub area are dedicated to the public.
- f. To require buildings developed in each sub area to be environmental sustainable.
- g. To require that any off-STREET motor vehicle parking be provided in underground commercial PARKING STRUCTURES.

#### 3. Applicability

- a. This Section is applicable to all real property within the Master Planned DEVELOPMENT (MPD) overlay district as shown on the maps of the Official Zoning Atlas of the City of Somerville.
- b. The provisions of each MPD sub-area are applicable to real property as shown on the maps for each sub area.
- c. The provisions of this Section supplement or supersede the provisions of the districts upon which it is superimposed. Where the provisions of this Section conflict with those found elsewhere in this Ordinance, the provisions of this Section apply.
- d. Development entitlement under this section is only applicable to real property following adoption of an urban design framework by the Planning Board for the sub-area where the property is located.

#### 4. Urban Design

- a. The Planning Board shall adopt an Urban Design Framework for each sub-area specified in this Section, excluding the North Point and the Somernova Innovation sub-areas sub-area.
- b. An Urban Design Framework may be adopted as part of a more comprehensive neighborhood plan or as a stand alone policy document.
- c. An Urban Design Framework must include, but may not be limited to, the intended alignment and connectivity of thoroughfares, ideal location and type

of civic spaces, and identification of advantageous sites for different building types permitted by the regulatory maps for each sub-area.

#### 5. Development Review

- a. General
  - i. Development entitlement under this section requires one of the following:
    - a). Master Planned Development: A Master Plan Special Permit issued prior to and as a prerequisite to any Subdivision Plan Approval, Site Plan Approval, or Special Permit required elsewhere in this Ordinance; or
    - b). Contributing Lot: a Special Permit issued in addition to and simultaneous with the Site Plan Approval required for a building type or civic space.
- b. Master Planned Development
  - i. Proposed development involving the subdivision of a development site or the development of two (2) or more lots requires a Master Plan Special Permit.
  - ii. Previously permitted development may be included in a development site and proposed build out of a Master Plan, provided that the date of the first certificate of occupancy, civic space permit, or thoroughfare permit for the subject real property is within two (2) years of the decision date of the master plan special permit.
- c. Contributing Lots
  - i. Development as a contributing lot is prohibited for any lot subject to an approved Master Plan Special Permit and may be restricted by the provisions of a specific sub area.
  - ii. In addition to the review criteria for all Special Permits specified in §15.2.1.e. Review Criteria, the review board shall make findings considering the following in its discretion to approve or deny a special permit authorizing DEVELOPMENT of a contributing LOT:
    - a). Consistency with the approved Urban Design Framework for the sub-area where the property is located.

#### 6. Master Plan Standards

- a. Submitted master plans must include a sustainability component that details the following:
  - i. Identification of all master plan scale efforts to mitigate climate change impacts identified in Somerville's Climate Change Vulnerability Assessment in relation to the design, construction, and occupancy or use of all thoroughfares, civic

## **8.4.19. Somernova Innovation (SI) Sub-Area**

### **Intent**

---

- i. To expand support and opportunities for the arts & creative economy.
- ii. To create a sustainable place that supports the needs and uses of an evolving commercial innovation ecosystem.
- iii. To create a series of interconnected buildings, spaces, and programs that support connecting opportunities, including Somerville's youth and the most vulnerable population.
- iv. To redevelop a former factory, introducing primarily commercial and mixed-use mid-rise and high-rise development that will enhance the existing innovation ecosystem focused on and supporting Climate Technology and other Tough Tech businesses.
- v. To expand the existing employment center holistically and equitably through various employment opportunities and workforce development programs.
- vi. To create new housing and incorporate the needs and uses of a 24-hour residential neighborhood into new multi-use buildings.

### **Purpose**

---

- i. To permit the redevelopment of the former factory campus to support the commercial goals of the City, particularly to maintain arts and creative enterprise space and to advance climate-tech and tough-tech innovation.
- ii. To require a community center to be included in any redevelopment as contemplated by the comprehensive plan of the City of Somerville.
- iii. To require new civic and arts spaces within the sub-area.
- iv. To permit additional building types, taller principal buildings, and larger building floorplates than would otherwise be permitted in the underlying zoning district.
- v. To permit use categories and principal uses than would otherwise be permitted by the underlying zoning district.
- vi. To permit flexibility in compliance with certain district and building type standards.
- vii. To establish a streamlined and expedited development review and permitting process. This process will allow companies focusing on Climate Tech and Tough Tech to expand and develop their climate solutions more quickly.

### **Applicability**

---

- i. This section is applicable to all real property shown on Map 8.4.19 (a).
- ii. Development Parcels are established as shown on Map 8.4.19 (b).
- iii. Development within the SI sub-area is exempt from the requirements of Section 8.4.3.d and Section 8.4.4.



**Map 8.4.19 (a) Overlay Boundary**



**Map 8.4.19 (b) Development Parcels**





## Development Review

---

- i. All development requires a Master Plan Special Permit as a prerequisite to any discretionary or administrative permit required for subdivision or the development of an individual lot. Any application requesting a Master Plan Special Permit must include the following:
  - a). A summary of the physical development plan that, at a minimum, includes the following:
    - i) the intended alignment and connectivity of thoroughfares;
    - ii) locations and types of civic spaces;
    - iii) advantageous sites for different building types permitted, and;
    - iv) Mobility plan summarizing the site access, layout of parking, loading, and mobility infrastructure with a focus on pedestrian and bicycle activities.
- ii. Development of real property as a contributing lot is prohibited.
- iii. Any pre-application meetings required for development identified in phase one (1) of any master plan subject to this section may be conducted concurrently with any pre-application meetings required for the master plan special permit application.
- iv. Site Plan Approval and Special Permit applications for development identified in phase one (1) of any master plan subject to this section may be submitted simultaneously with the application for the Master Plan special permit. The Master Plan special permit must be approved before phase one (1) may receive any approvals.
- v. In addition to the review criteria for Site Plan Approval specified in §15.3.2.e. Review Criteria, the review board shall make findings considering the following:
  - a). Conformance with any approved Master Plan Special Permit and any other Special Permits applicable to the subject lot.

## Master Plan Standards

---

- i. Master plans that include greater than one hundred thousand (100,000) square feet of gross floor area must include the following uses of proposed gross floor area:
  - a). At least ten thousand (10,000) gross square feet of area must be dedicated to principal uses from the community center use category.
  - b). A minimum of five percent (5%) of the total gross floor area across the total gross floor area of the Development Site must be uses from the Residential use categories.
  - c). At least three hundred and seventy-five (375) square feet of non-residential gross floor space for each dwelling unit.
- ii. Within the entire Development Site, regardless of the number of square feet, a minimum of five percent (5%) of the total gross leasable commercial floor space must be provided as leasable floor area from the Arts & Creative Enterprise use category.
- iii. Master plans that include greater than one hundred thousand (100,000) square feet of gross floor area must include the following Arts requirements:
  - a). Within the total required Arts & Creative Enterprise square footage, a development must provide a minimum of twenty-five thousand square feet (25,000 sf) of leasable floor space for Arts Exhibition, Artisanal Production, Arts Sales or Services, or Shared Workspaces or Arts Education uses to enhance the local music ecosystem for artists to write, rehearse, record, perform & learn.
  - b). To further enhance the local music ecosystem for artists and encourage the creative, flexible, and economic use of space, commercial spaces that incorporate Food & Beverage Service uses with Arts Exhibition uses may include the entire leaseable floor space of both the principal and accessory uses when calculating the total Arts & Creative Enterprise Uses within the Development Site.
  - c). A Development may fulfill up to 50% of its required Arts & Creative Enterprise space off-site of the Development Site.



- i) The off-site space must serve the intended arts and creative purposes. The quality, size, and accessibility of off-site spaces must be equivalent to or exceed that which would have been provided on-site.
  - ii) A Development must include details for off-site Arts & Creative Enterprise space as part of their development application. The off-site plan must detail the location, size, design, and management plan for the off-site space.
  - iii) The off-site plan for the Arts & Creative Enterprise space included in the development application must detail who is responsible for maintaining and operating the spaces.
  - iv) The Planning Board shall review and approve all proposals for off-site space provision. The development review will consider the space's contribution to the city's cultural landscape.
  - v) A covenant or other legal instrument must be recorded against the off-site property, guaranteeing its continuous use as Arts & Creative Enterprise space in perpetuity.
- d). Public Art. A building or structure must include at least one work of Public Art, with no maximum, meeting the requirements of this section, which is intended to allow for the broadest definition of Public Art and encourage imaginative interpretation of media.
- i) Public Art may include, but need not be limited to, the following, separately or in combination:
    - 1. Sculpture;
    - 2. Murals or paintings;
    - 3. Earthworks, waterworks, fiber works, functional elements, furnishings, neon, glass mosaics, photography, prints, or calligraphy, in any combination of forms of media including sound, film, holographic, and video systems; hybrids of any media and new genres; and
    - 4. Lighting in any combination or form.
  - ii) A Development may locate Public Art within a building or structure, upon a building or structure, or within the public realm, including any Civic Spaces. If authorization from the city is obtained, Public Art may be provided within the public sidewalk. Public Art can be located on any story of a building or structure and may be any size and shape.
  - iii) Non-Commercial Nature: Any depiction of commercial entities or products must be incidental and not serve as the primary focus of the Public Art.
- iv. Urban Design
- a). Thoroughfare Network
    - i) Any Master Plan that includes lots MBL 53/A/9 and MBL 53/A/10 must create one (1) alley or lane that connects Park Street to Properzi Way that provides vehicular access between the two existing streets.
    - ii) Any Master Plan that includes lots MBL 53/A/9A, 11, 12, 13, and 14 must create one (1) thoroughfare, which may be designed as part of a larger Civic Space, connecting Park Street to Properzi Way to provide pedestrian and bicycle access between the two existing streets.
    - iii) Any Master Plan that includes lots MBL 64/A/8 and MBL 64/A/9 must create an alley or lane that connects Dane Street to either lot MBL 64/A/5 or MBL 64/A/8. The new thoroughfare may be covered by buildings or structures as long as a fourteen foot clear head height is maintained.
    - iv) All intersections are at least one hundred (100) feet from any other intersection, unless granted a waiver by the Planning Board.
    - v) A thoroughfare designed as a shared street that prioritizes walking and promotes safe, extremely low vehicle speeds is permitted, provided that the overall connectivity of the thoroughfare network is maintained and the curbless pedestrian and vehicle space is textured or permeable paved to reinforce the pedestrian-priority operation of the street, subject to the approval by the Director of Mobility.



- b). Public Realm. Master plans that include greater than one hundred thousand (100,000) square feet of gross floor area must improve at least twenty percent (20%) of the Development Site, excluding thoroughfares, as follows:
- i) At least sixty five percent (65%) must be provided as one or more Civic Spaces or Public Rooms.
  - ii) Up to thirty percent (35%) may be provided in the form of public realm improvements to streetscape along the frontage of a thoroughfare or civic space.
  - iii) Public Room is an interior space suitable for civic, cultural, ecological, recreational, or social functions and may be included as part of the required public realm allocation, contingent upon:
    1. The space is within a building that allows for year-round, climate-controlled use by the public and that has access to a Thoroughfare, Civic Space, transit concourses or transit stations either directly or through another connecting area open to the public.
    2. The space shall meet all public access design and engineering requirements for areas required to be accessible to those with physical impairments under the Americans with Disabilities Act.
    3. The space shall include a minimum of 5,000 square feet of floor area and shall have a minimum unobstructed height of 15 feet.
    4. The space must include access to a public amenity, such as retail sales, cultural exhibits, eating and drinking establishments, public restrooms, or other attraction. A Public Room is not a lobby that is a portion of a building tenant's leasable area.
    5. Seating shall be provided within the space.
    6. The space shall be open to the public at times during the hours of 8:00 a.m. to 9:00 p.m. daily. The space may be closed at times to the public with posted, advanced notice for purposes of maintenance, private events, or other such activities that may happen from time to time.
  - iv) Any areas designated as a Community Center use may be included as part of the required public realm allocation.
- c). Civic Space
- i) Civic Space created through easement or decommissioning of an existing thoroughfare or other right-of-way may be included as part of the required public realm allocation.
  - ii) Development Parcels must provide the following minimum Civic Spaces size:
    1. Development Parcel 1 (D-1) must provide a Civic Space of at least five thousand (5,000) square feet.
    2. Development Parcel 2 (D-2) must provide a Civic Space of at least twenty-five thousand (25,000) square feet.
    3. Development Parcel 3 (D-3) must provide a Civic Space of at least five thousand (5,000) square feet and abut Dane Street.
- d). Development fronting Somerville Avenue
- i) To enhance the street wall of Somerville Avenue, any Master Plan that includes buildings or structures fronting onto Somerville Avenue must include on the Somerville Avenue frontage an upper-story step back of at least twenty-nine feet (29') at an elevation above grade of sixty-five feet (65') and an upper-story step back of at least seventy feet (70') at an elevation above grade of ninety feet (90').

### Lot Standards

---

- i. Development Parcel 3 (D-3) is exempt from Section 10.1.4.a.

**Building Types**

---

- i. The following additional principal building types are permitted in the Somernova Innovation Sub-Area:
  - a). Flex Commercial Building
  - b). General Building



### **Flex Commercial Building**

A large floor plate, multi-story building type purpose built to maximize flexibility in accommodating the needs of primarily research and development principal uses. Flex commercial buildings are typically designed with floor space that may be demised in various ways, high floor-to-floor heights, expansive windows, wide corridors, service elevators, and multiple loading docks.

The following images are examples of the Flex Commercial Building type and are intended only for illustrative purposes.



i. Lot Standards

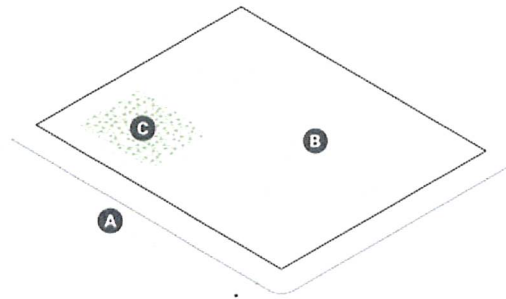

Lot Dimensions

<u>A</u>	<u>Lot Width (min)</u>	<u>30 ft</u>
----------	------------------------	--------------

Lot Development

<u>B</u>	<u>Lot Coverage (max)</u>	<u>100%</u>
	<u>Green Score (min)</u>	<u>0.20</u>
<u>C</u>	<u>Open Space (min)</u>	<u>25%</u>

ii. Building Placement

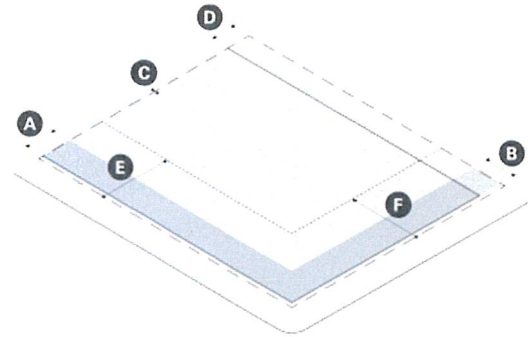

Building Setbacks

	<u>Curb Setback (min)</u>	<u>12 ft</u>
<u>A</u>	<u>Primary Front Setback (min/max)</u>	<u>2 ft 15 ft</u>
<u>B</u>	<u>Secondary Front Setback (min/max)</u>	<u>2 ft 15 ft</u>
<u>C</u>	<u>Side Setback (min)</u>	<u>0 ft</u>
	<u>Abutting an Alley or R-ROW</u>	<u>0 ft</u>
	<u>Abutting any non-NR</u>	<u>0 ft</u>
	<u>1<sup>st</sup> – 3<sup>rd</sup> Story Abutting NR</u>	<u>10 ft</u>
	<u>4<sup>th</sup> Story and above Abutting NR</u>	<u>30 ft</u>
<u>D</u>	<u>Rear Setback (min)</u>	<u>=</u>
	<u>Abutting an Alley or R-ROW</u>	<u>0 ft</u>



Abutting any non-NR                      10 ft

Abutting NR                                      20 ft

**Parking Setbacks**

E    Primary Front Setback (min)                      20 ft

F    Secondary Front Setback (min)                      20 ft

iii. Massing & Height

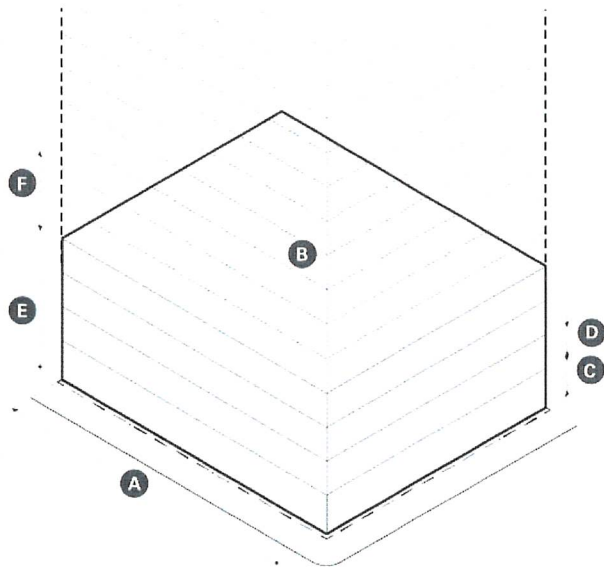

d. Uses & Features

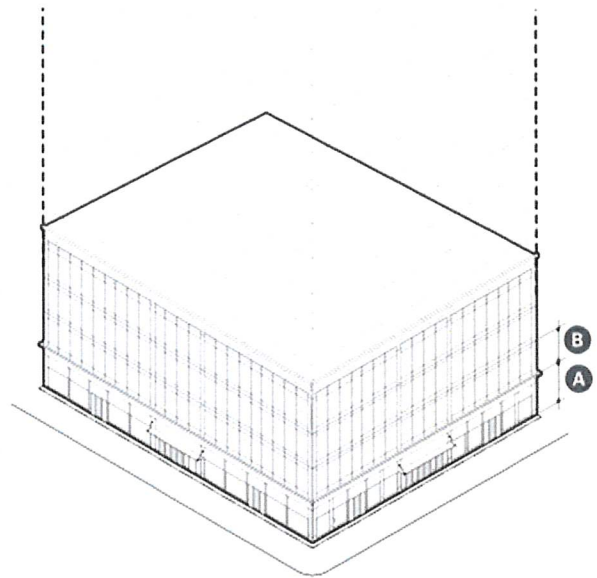

**Main Mass**

<u>A</u>	<u>Building Width (max)</u>	<u>n/a</u>
	<u>Facade Build Out (min)</u>	<u>=</u>
	<u>Primary Front</u>	<u>65%</u>
	<u>Secondary Front</u>	<u>65%</u>
<u>B</u>	<u>Floor Plate (max)</u>	<u>45,000 sf</u>
<u>C</u>	<u>Ground Story Height (min)</u>	<u>18 ft</u>
<u>D</u>	<u>Upper Story Height (min)</u>	<u>14 ft</u>
<u>E</u>	<u>Number of Stories (min)</u>	<u>2 Stories</u>
<u>F</u>	<u>Number of Stories (max)</u>	<u>9 Stories</u>

**Facade Composition**

<u>A</u>	<u>Ground Story Fenestration</u>	<u>=</u>
	<u>Primary Facade (min)</u>	<u>50%</u>
	<u>Secondary Facade (min/max)</u>	<u>15 % 70 %</u>
<u>B</u>	<u>Upper Story Fenestration (min/max)</u>	<u>15 % 70 %</u>
	<u>Blank Wall (max)</u>	<u>50 ft</u>

**Use & Occupancy**

<u>Entrance Spacing (max)</u>	<u>30 ft</u>
<u>Commercial Space Depth (min)</u>	<u>30 ft</u>

Building Height, Feet  
(max)

185 ft

Roof Type

Flat





**General Building**

A large floor plate, multi-story principal building type with ground story commercial space and no limitations on the occupancy of upper stories for permitted uses. The upper stories of a general building are typically residential, but a wide variety exists. As the number of stories increases, it becomes more likely for the upper stories of a general building to host commercial uses as well as residential.

The following images are examples of the general building type and are intended only for illustrative purposes.





i. Lot Standards

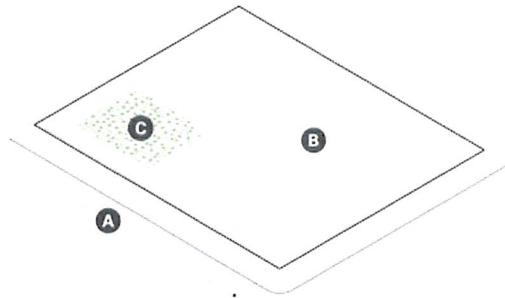

Lot Dimensions

<u>A</u>	<u>Lot Width (min)</u>	<u>30 ft</u>
----------	------------------------	--------------

Lot Development

<u>B</u>	<u>Lot Coverage (max)</u>	<u>100%</u>
----------	---------------------------	-------------

	<u>Green Score</u>	<u>=</u>
--	--------------------	----------

	<u>Minimum</u>	<u>0.20</u>
--	----------------	-------------

	<u>Ideal</u>	<u>0.25</u>
--	--------------	-------------

<u>C</u>	<u>Open Space (min)</u>	<u>15%</u>
----------	-------------------------	------------

ii. Building Placement

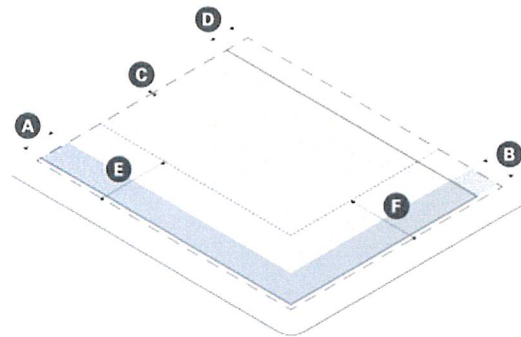

Building Setbacks

	<u>Curb Setback (min)</u>	<u>12 ft</u>
--	---------------------------	--------------

<u>A</u>	<u>Primary Front Setback (min/max)</u>	<u>2 ft 15 ft</u>
----------	--	-------------------

<u>B</u>	<u>Secondary Front Setback (min/max)</u>	<u>2 ft 15 ft</u>
----------	--	-------------------

<u>C</u>	<u>Side Setback (min)</u>	<u>=</u>
----------	---------------------------	----------

	<u>Abutting an Alley or R-ROW</u>	<u>0 ft</u>
--	-----------------------------------	-------------

	<u>Abutting any non-NR</u>	<u>0 ft</u>
--	----------------------------	-------------

	<u>1<sup>st</sup> – 3<sup>rd</sup> Story Abutting NR</u>	<u>20 ft</u>
--	--	--------------

	<u>4<sup>th</sup> – 11<sup>th</sup> Story Abutting NR</u>	<u>30 ft</u>
--	---	--------------

<u>D</u>	<u>Rear Setback (min)</u>	<u>=</u>
----------	---------------------------	----------



Abutting an Alley or R-ROW 0 ft

Abutting any non-NR 10 ft

1<sup>st</sup> – 3<sup>rd</sup> Story Abutting NR 20 ft

4<sup>th</sup> – 6<sup>th</sup> Story Abutting NR 30 ft

#### Parking Setbacks

E Primary Front Setback (min) 30 ft

F Secondary Front Setback (min) 30 ft

iii. Massing & Height

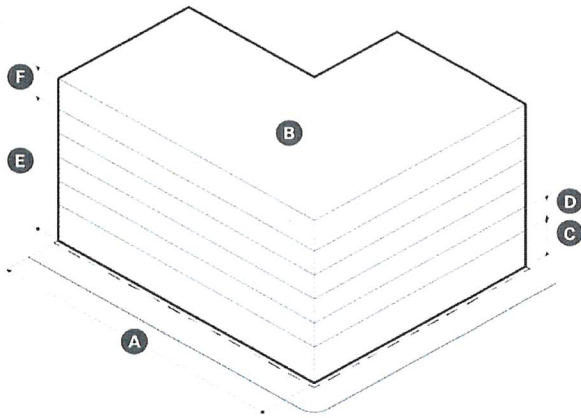

iv. Uses & Features

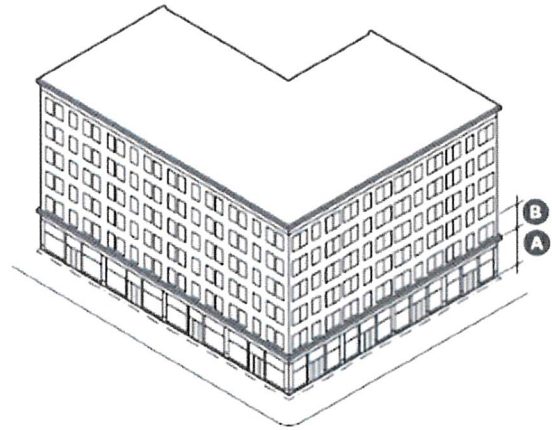

Main Massing

<u>A</u>	<u>Building Width (max)</u>	<u>275 ft</u>
	<u>Facade Build Out (min)</u>	<u>=</u>
	<u>Primary Front</u>	<u>80%</u>
	<u>Secondary Front</u>	<u>65%</u>
<u>B</u>	<u>Floor Plate (max)</u>	<u>30,000 sf</u>
<u>C</u>	<u>Ground Story Height (min)</u>	<u>18 ft</u>
<u>D</u>	<u>Upper Story Height (min)</u>	<u>9 ft</u>
<u>E</u>	<u>Number of Stories (max)</u>	<u>11</u>

Facade Composition

<u>A</u>	<u>Ground Story Fenestration</u>	<u>=</u>
	<u>Primary Facade (min)</u>	<u>70%</u>
	<u>Secondary Facade (min/max)</u>	<u>15 % 70 %</u>
<u>B</u>	<u>Upper Story Fenestration (min/max)</u>	<u>15 % 50 %</u>
	<u>Blank Wall (max)</u>	<u>20 ft</u>

Use & Occupancy

<u>Ground Story Entrance Spacing (max)</u>	<u>30 ft</u>
--	--------------



<u>F</u>	<u>Building Height, Feet (max)</u>	<u>130 ft</u>	<u>Commercial Space Depth (min)</u>	<u>30 ft</u>
	<u>Roof Type</u>	<u>Flat</u>	<u>Density Factor (min)</u>	<u>=</u>
			<u>Lot Area &lt; 7,000 sf</u>	<u>1,125</u>
			<u>Lot Area &gt;= 7,000 sf</u>	<u>875</u>
			<u>Net Zero Ready Building</u>	<u>650</u>
			<u>Outdoor Amenity Space (min)</u>	<u>1/DU</u>

**a. Development Benefits**

- i. Development is subject to the provisions of Article 12: Development Benefits of this Ordinance. Where the provisions of this section conflict with those of Article 12, the provisions of Article 8.4.19 apply.
- ii. Development of General Building containing residential units must provide affordable dwelling units as specified on Table 8.4.19 (a).
- iii. The gross floor area of any Community Center principal use is deducted from the total gross floor area of any building for the purpose of calculating the linkage payment subject to Section 12.2 Linkage.

**Table 8.4.19 (a) Required ADUs**

<u>Total Dwelling Units</u>	<u>Required ADUs</u>
<u>0 to 3 units</u>	<u>None</u>
<u>4 or more units</u>	<u>20% of units</u>

**b. Building Standards**

- i. The standards of Table 8.4.19 (b) supersede specific dimensional standards as indicated in Sections 8.4.19.X.iii Flex Commercial Building, 8.4.19.X.iii General Building, for specific development parcels.
- ii. Development may deviate above or below by five percent (5%) from the numeric value of the following dimensional standards:
  - a). Front building setbacks (min/max)
  - b). Facade build out (min)
  - c). Floor plate (max)
  - d). Building Height, Feet (max)
- iii. Ground story facades are exempt from the ground story entrance spacing requirement for each building type for the width of any façade corresponding to a commercial space occupied by a Community Center principal use.

**Table 8.4.19 (b) Superseding Dimensional Standards by Development Parcel**

	<u>Building Type</u>	<u>Floor Plate (max)</u>	<u>Building Height, Feet (max)</u>	<u>Primary Front Setback (max)</u>
<u>D1</u>	<u>Flex Commercial Building</u>	<u>50,000 sf</u>	<u>165 ft</u>	<u>=</u>
	<u>General Building</u>	<u>=</u>	<u>=</u>	<u>=</u>
<u>D2</u>	<u>Flex Commercial Building</u>	<u>30,000 sf</u>	<u>130 ft</u>	<u>=</u>
	<u>General Building</u>	<u>=</u>	<u>85 ft</u>	<u>=</u>
<u>D3</u>	<u>Flex Commercial Building</u>	<u>75,000 sf</u>	<u>185 ft</u>	<u>65 ft</u>
	<u>General Building</u>	<u>=</u>	<u>=</u>	<u>65 ft</u>



D4	<u>Flex Commercial Building</u>	=	<u>130 ft</u>	=
	<u>General Building</u>	=	<u>85 ft</u>	=

- iv. Development may deviate from the numeric value of any of the standards listed in Table 8.4.19(b) but not exceed a maximum standard indicated in Sections 8.4.19.X.iii Flex Commercial Building, 8.4.19.X.iii General Building by Special Permit. In addition to the review criteria for all Special Permits specified in §15.2.1.e. Review Criteria, the review board shall make findings considering the following in its discretion to approve or deny a special permit authorizing dimensional deviation from Section 8.4.19.(b):
- a). If the proposed deviation can provide a positive refinement of the massing of a building in context to its surroundings, improve floor plate efficiency, provide for unique storefront design, or better address specific operational requirements of commercial tenants.
  - b). Consistency with implementing the housing policy objectives of the comprehensive plan of the City of Somerville by increasing the supply of housing and affordable housing available to existing and future residents.

**c. Building Components**

- i. Arcade
- a). A building or structure incorporating an Arcade along the frontage of any Thoroughfare may provide the ADA compliant sidewalk within the Arcade and does not need to provide an additional sidewalk outside the Arcade.
  - b). A compliant sidewalk can be provided all or in part on private property.
  - c). Arcades may be up to two (2) stories in height.

**d. Use Provisions**

- i. The standards of Table 8.4.19 (d) supersede the table of permitted uses for the underlying zoning district for development subject to an approved Master Plan Special Permit.
- ii. Principal uses from the Research & Development or Laboratory use category may include the ancillary development of mockup and prototype products without restrictions.

**Table 8.4.19 (c) Permitted Uses**

<u>Use Category</u> <u>Specific Use</u>	<u>CE</u>
<u>Arts &amp; Creative Enterprise</u>	
<u>Artisanal Production</u>	<u>P</u>
<u>Arts Exhibition</u>	<u>P</u>
<u>Arts Sales &amp; Services</u>	<u>P</u>
<u>Co-working</u>	<u>P</u>
<u>Design Services</u>	<u>P</u>

**Table 8.4.19 (c) Permitted Uses**

<u>Use Category</u> <u>Specific Use</u>	<u>CE</u>
<u>Arts Shared Workspaces</u>	<u>P</u>
<u>Arts Education</u>	<u>P</u>
<u>Cannabis Establishment</u>	
<u>Cannabis Cultivation</u>	<u>P</u>
<u>Cannabis Retail Sales</u>	<u>SP</u>
<u>Cannabis Research &amp; Development</u>	<u>P</u>
<u>Cannabis Testing Laboratory</u>	<u>P</u>
<u>Civic &amp; Institutional</u>	
<u>Community Center</u>	<u>P</u>
<u>Library</u>	<u>P</u>
<u>Museum</u>	<u>P</u>
<u>Minor Utility Facility</u>	<u>SP</u>
<u>Public Service</u>	<u>P</u>
<u>Religious &amp; Educational Uses Protected by M.G.L. 40A. Sec. 3</u>	<u>P</u>
<u>Commercial Services</u>	
<u>Assembly or Entertainment</u>	<u>P</u>
<u>Broadcast or Recording Studio</u>	<u>P</u>
<u>Business Support Services</u>	<u>P</u>
<u>Caterer or Wholesale Food Production</u>	<u>P</u>
<u>Day Care Service (as noted below)</u>	<u>=</u>
<u>Adult Day Care Center</u>	<u>P</u>
<u>Child Day Care Center</u>	<u>P</u>
<u>Educational Services</u>	<u>P</u>
<u>Maintenance &amp; Repair of Consumer Goods</u>	<u>P</u>



**Table 8.4.19 (c) Permitted Uses**

<b>Use Category</b> <b>Specific Use</b>	<b>CE</b>
<b><u>Personal Services (except as follows)</u></b>	<b><u>P</u></b>
<u>Fitness Services</u>	<b><u>P</u></b>
<u>Health Care Services</u>	<b><u>P</u></b>
<u>Recreation Services</u>	<b><u>P</u></b>
<b><u>Vehicle Parking (as noted below)</u></b>	<b><u>=</u></b>
<u>Bike Share Parking</u>	<b><u>P</u></b>
<u>Car Share Parking (3 or fewer spaces)</u>	<b><u>P</u></b>
<u>Car Share Parking (4 or more spaces)</u>	<b><u>P</u></b>
<u>Commercial Parking</u>	<b><u>P</u></b>
<b><u>Food and Beverage Services</u></b>	
<u>Bar, Restaurant, or Tavern</u>	<b><u>P</u></b>
<u>Bakery, Café, or Coffee Shop</u>	<b><u>P</u></b>
<b><u>Lodging</u></b>	
<u>Hotel or Hostel</u>	<b><u>P</u></b>
<b><u>Office</u></b>	
<u>General Office</u>	<b><u>P</u></b>
<u>Research &amp; Development or Laboratory</u>	<b><u>P</u></b>
<b><u>Industrial</u></b>	
<u>Manufacturing</u>	<b><u>P</u></b>
<u>Data Center</u>	<b><u>SP</u></b>
<u>Wholesale Trade or Distribution<sup>1</sup></u>	<b><u>P</u></b>
<b><u>Residential</u></b>	
<u>Residential Living</u>	<b><u>P</u></b>

**Table 8.4.19 (c) Permitted Uses**

<b>Use Category</b> <b>Specific Use</b>	<b>CE</b>
<u>Group Living</u>	<u>P</u>
<u>Dormitory or Chapter House</u>	<u>N</u>
<u>Homeless Shelter</u>	<u>N</u>
<u>Nursing Home/Assisted Living Facility</u>	<u>N</u>
<u>Artist Housing</u>	<u>P</u>
<u>Rooming House</u>	<u>P</u>
<b><u>Retail Sales</u></b>	
<b><u>Building/Home Supplies &amp; Equipment</u></b>	<u>P</u>
<b><u>Consumer Goods (except as follows)</u></b>	<u>P</u>
<u>Firearms Sales</u>	<u>N</u>
<b><u>Fresh Food Market or Grocery Store</u></b>	<u>P</u>
<b><u>Farm/Vendor Market</u></b>	<u>P</u>
<b><u>Urban Agriculture</u></b>	
<b><u>Farming (as noted below)</u></b>	<u>=</u>
<u>Commercial Farming</u>	<u>P</u>
<u>Community Farming</u>	<u>P</u>
<b><u>Community Gardening</u></b>	<u>P</u>
<b><u>Accessory Uses</u></b>	
<b><u>Home Occupations (as noted below)</u></b>	<u>=</u>
<u>Creative Studio</u>	<u>P</u>
<u>Home-Based Business</u>	<u>P</u>
<u>Home Office</u>	<u>P</u>
<b><u>Urban Agriculture (as noted below)</u></b>	<u>=</u>
<u>Apiculture</u>	<u>P</u>



**Table 8.4.19 (c) Permitted Uses**

<u>Use Category</u> <u>Specific Use</u>	<u>CE</u>
<u>Aviculture</u>	<u>P</u>
<u>Commercial Farming</u>	<u>P</u>
<u>Residential Gardening</u>	<u>P</u>

P - Permitted • SP - Special Permit Required • N - Not Permitted

- <sup>1.</sup> The wholesale and/or storage or warehousing of toxic and/or hazardous materials is permitted.

**e. Development Standards**

- i. Accessory Structures
  - a). Any roof top greenhouse may be up to twenty-five (25) feet in height and is excluded from the calculation of the building height and number of stories.
- ii. Sustainable Roofs
  - a). All new principal building types must include a green roof, photovoltaic (PV) devices, or both for 100% of the roof area not occupied by building systems equipment or outdoor amenity spaces.
- iii. Roof-Mounted Mechanical
  - a). Roof mounted mechanical equipment must be screened or enclosed within a rooftop penthouse.
    - i) Roof-mounted photovoltaic (PV) devices, solar thermal systems, and wind power generators are exempt.
    - ii) Rooftop mechanical penthouses should be designed as an integral part of the overall building aesthetic and their design should harmoniously align with the building's architectural style and façade composition.
    - iii) If the use of an enclosed penthouse is for mechanical equipment, other building systems, and/or Arts & Creative Enterprise Uses then it will not be considered a building Story or included in calculating the height of a building.
- iv. Screening
  - a). Loading Facilities
    - i) Outdoor loading facilities are exempt from Section 10.7.2 Loading Facilities.
    - ii) If a Loading Facility is served from an Alley it is exempt from Article 10.7.2 Loading Facilities.
- v. Signage Standards.
  - a). Development is subject to the provisions of Article 10: Development Standards of this Ordinance. Where the provisions of this section conflict with those of Article 10, the provisions of Article 8.4.19 apply.
  - b). Roof or Skyline Sign
    - i) One building or structure within the Development Site is permitted to have up to two (2) Roof or Skyline Signs.
    - ii) A Roof or Skyline Sign may be up to one thousand four hundred square feet (1,400 sf) in area and may extend above the top portion of a façade no greater than fifteen (15') feet.

- iii) Neon is permitted if it is Dark Sky compliant and procured from an artist.

**f. Parking & Mobility**

i. Bicycle Parking

- a). Development is subject to the provisions of Article 11: Parking & Mobility of this Ordinance. Where the provisions of this section conflict with those of Article 11, the provisions of this section Article 8.4.19 apply.
- b). The standards of Table 8.4.19 (d) supersede the table of bicycle parking for the underlying zoning district for development subject to an approved Master Plan Special Permit.

ii. Vehicle Parking

- a). Development is exempt from any minimum motor vehicle parking requirements of any underlying zoning district.
- b). The maximum number of off-street parking spaces in development parcels one (1), two (2), three (3), and four (4) may be at most seven hundred fifty (750) spaces total.

iii. Temporary Surface Parking. Motor vehicle parking spaces may be provided as surface parking on a revolving two (2) year basis for real property in the sub-area by Special Permit.

- a). In addition to the review criteria for all Special Permits specified in §15.2.1.e. Review Criteria, the review board shall make findings considering the following in its discretion to approve or deny a special permit authorizing an interim surface parking lot:
  - i) Documented unmet demand for parking;
  - ii) The development schedule and phasing for development are subject to a Master Plan Special Permit;
  - iii) The capacity of the local thoroughfare network providing access to the site; and
  - iv) The impact of the parking lot on pedestrian, bicycle, and motor vehicle traffic and circulation patterns in the neighborhood.

**Table 8.4.19(d) Bicycle Parking**

<u>Use Category</u> <u>Specific Use</u>	<u>Short-Term (min)</u>	<u>Long-Term (min)</u>
<b><u>Arts &amp; Creative Enterprise</u></b>		
<u>All Permitted Uses</u>	<u>1 / 9,000 sf</u>	<u>1 / 2,700 sf</u>
<b><u>Cannabis Establishment</u></b>		
<u>Cannabis Product Manufacturing</u>	<u>1 / 9,000 sf</u>	<u>1 / 2,700 sf</u>
<u>Cannabis Retail Sales</u>	<u>1 / 2,250 sf</u>	<u>1 / 9,000 sf</u>
<u>Cannabis Research &amp; Development</u>	<u>1 / 18,000 sf</u>	<u>1 / 4,500 sf</u>
<u>Cannabis Testing Laboratory</u>	<u>1 / 18,000 sf</u>	<u>1 / 4,500 sf</u>



**Table 8.4.19(d) Bicycle Parking**

<u>Use Category</u> <u>Specific Use</u>	<u>Short-Term (min)</u>	<u>Long-Term (min)</u>
<b><u>Civic &amp; Institutional</u></b>		
<u>Community Center</u>	<u>1 / 9,000 sf</u>	<u>4 / 9,000 sf</u>
<u>Library</u>	<u>1 / 2,700 sf</u>	<u>1 / 4,500 sf</u>
<u>Museum</u>	<u>1 / 1,800 sf</u>	<u>1 / 9,000 sf</u>
<b><u>Commercial Services (except as follows)</u></b>		
<u>All Permitted Uses (except as follows)</u>	<u>1 / 2,250 sf</u>	<u>1 / 9,000 sf</u>
<u>Assembly or Entertainment</u>	<u>1 / 36 seats</u>	<u>1 / 9,000 sf</u>
<u>Day Care Service</u>	<u>3</u>	<u>1 / 9,000 sf</u>
<b><u>Food and Beverage Services</u></b>		
<u>All Permitted Uses</u>	<u>1 / 900 sf</u>	<u>1 / 4,500 sf</u>
<b><u>Lodging</u></b>		
<u>Hotel or Hostel</u>	<u>1 / 18 rooms</u>	<u>1 / 9 rooms</u>
<b><u>Office</u></b>		
<u>General Office</u>	<u>1 / 18,000 sf</u>	<u>1 / 2,700 sf</u>
<u>Research &amp; Development or Laboratory</u>	<u>1 / 18,000 sf</u>	<u>1 / 4,500 sf</u>
<b><u>Industrial</u></b>		
<u>Manufacturing</u>	<u>1 / 9,000 sf</u>	<u>1 / 2,700 sf</u>
<u>Data Center</u>	<u>--</u>	<u>--</u>
<u>Wholesale Trade or Distribution</u>	<u>1 / 36,000 sf</u>	<u>1 / 2,700 sf</u>
<b><u>Residential</u></b>		
<u>Residential Living</u>	<u>0.11 / DU</u>	<u>1.10 / DU</u>

**Table 8.4.19(d) Bicycle Parking**

<b>Use Category Specific Use</b>	<b>Short-Term (min)</b>	<b>Long-Term (min)</b>
<u>Group Living</u>	<u>0.06 / room</u>	<u>0.55 / room</u>
<u>Dormitory or Chapter House</u>	<u>0.11 / room</u>	<u>0.55 / room</u>
<u>Homeless Shelter</u>	<u>=</u>	<u>=</u>
<u>Nursing Home/Assisted Living Facility</u>	<u>=</u>	<u>=</u>
<u>Artist Housing</u>	<u>0.11 / DU</u>	<u>1.10 / DU</u>
<u>Rooming House</u>	<u>=</u>	<u>=</u>
<b><u>Retail Sales</u></b>		
<u>Building/Home Supplies &amp; Equipment</u>	<u>1 / 2,250 sf</u>	<u>1 / 9,000 sf</u>
<u>Consumer Goods (except as follows)</u>	<u>1 / 2,250 sf</u>	<u>1 / 9,000 sf</u>
<u>Fresh Food Market or Grocery Store</u>	<u>1 / 900 sf</u>	<u>1 / 9,000 sf</u>
<u>Farm/Vendor Market</u>	<u>n/a</u>	<u>n/a</u>